



Assembly Instructions

SPEEDY EASY UP TENTS

10'x10' (50mm)

10'x20' (50mm)

13'x26' (50mm)

10'x10' (40mm)

10'x20' (40mm)

Speed Easy Up Tents

Speedy Easy Up Tents are the ultimate in instant shelters. This is a perfect shelter if you are an individual looking for an instant shelter to use in your backyard or take to sporting events or if you are a commercial customer looking for an affordable, robust professional looking shelter for your next event, trade show, business or outdoor market place. Speedy Easy Up Tents will provide years of use to both consumers and businesses. Our superior quality and materials will more than satisfy your expectations.

STEP 1. CHECK ITEM LIST

- Tent Canopy and Frame
- Tie Down Kit (nylon ropes and hook stakes)
- Heavy Duty Wheeled Storage Bag

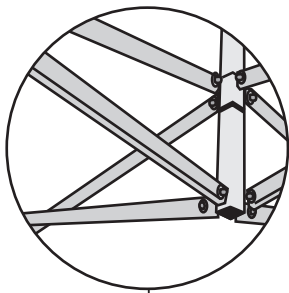

High Strength Internal Cross Bars

Fully Water Proof, Polyester Canopy— with Inner PVC Rain Gaurd Coating

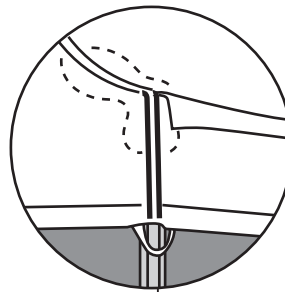

Reinforced Canopy Corners

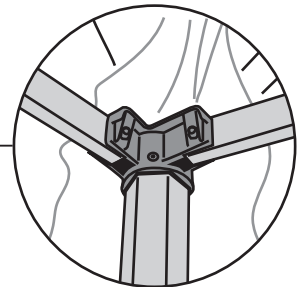

High Strength Corner Cap

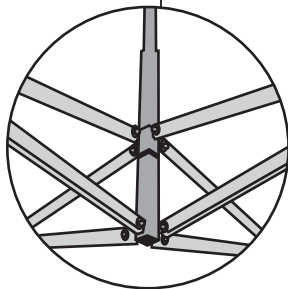

High Performance Center Peak Tension Bar

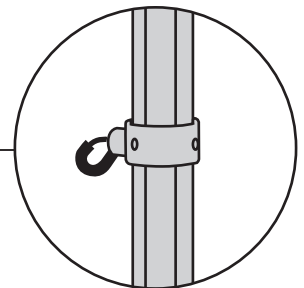

Quick Release Alloy Fitting—Reinforced Spring and Pull Pin System

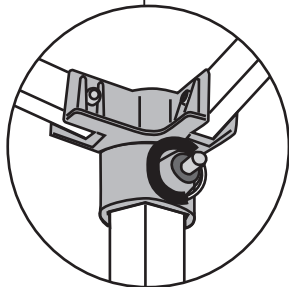

Cast Alloy Slider Fitting with Pull Pin

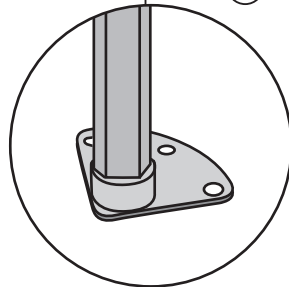

Stainles Steel Foot Plate

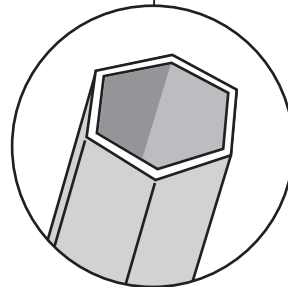

Hexagonal Industry Alloy Frame—(50mm/40mm)

STEP 2. POSITION FRAME

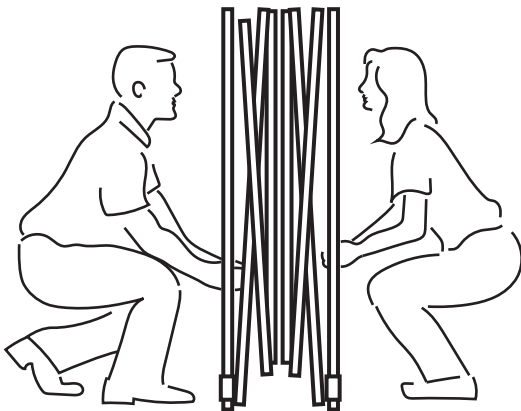

- Place frame on level ground, in the desired location
- **Note:** The first time you assemble your Speedy Tent the frame will be separate from canopy
- Two people should be positioned on opposite sides of frame
- Locate *diamond* portion of the cross bars see (**figure A**)
- Open the frame by having both people pull and stepping backward—only open 3/4s of the way

FIGURE A. HAND POSITION

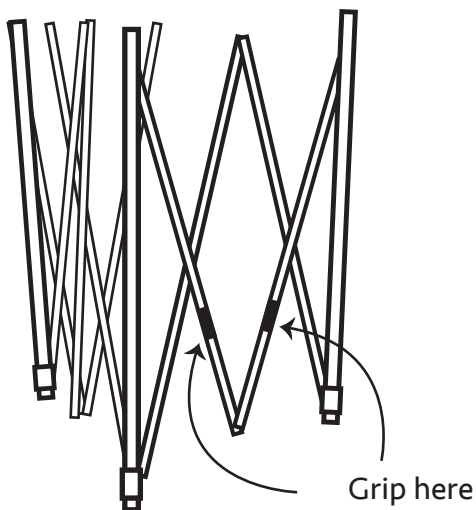

- Locate the lower *diamond*, on the cross bars
- Gripping the cross bars at this point will give you the best leverage when pulling the tent frame open
- **Note:** Pulling on opposite legs also works, as a method to open frame

STEP 3. ATTACH CANOPY

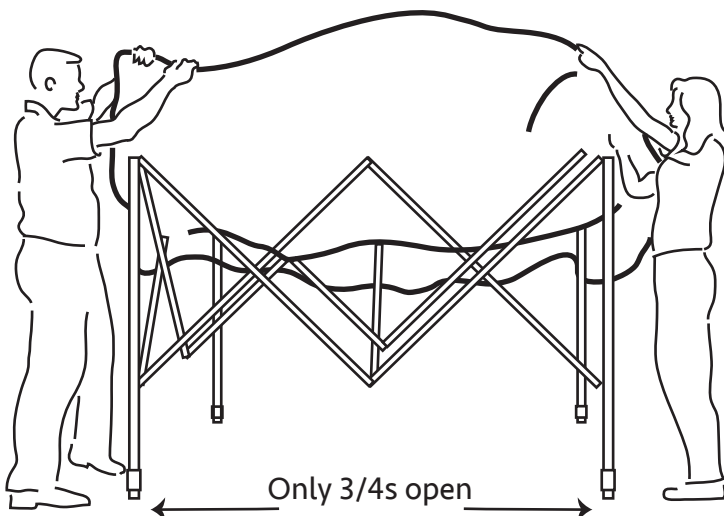

- Carefully lift canopy over frame
- Center, as best you can
- Pull corners to their respective corner legs
- Locate hook and loop strips, on top of the corner legs—line up strips from canopy and connect the two— see (**figure B**)

FIGURE B. CONNECTING HOOK STRIPS

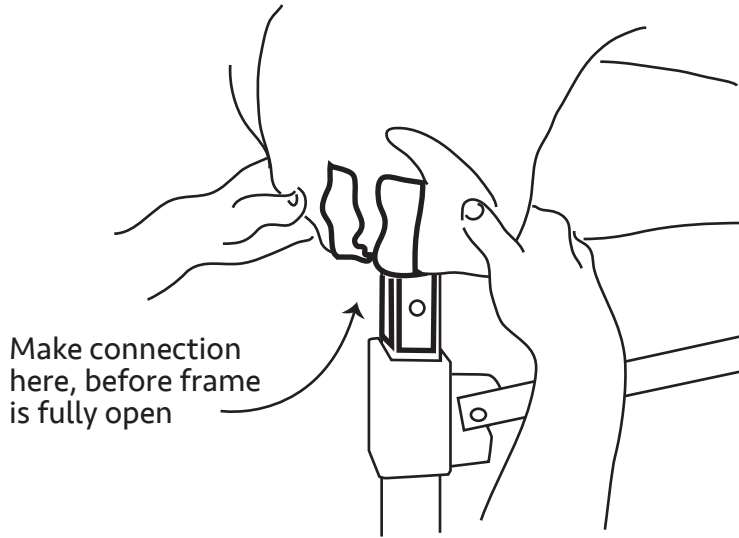

- At the top of each corner leg you will find the hook strip
- Align corner of canopy so that the corner seam sits on top of leg
- Align hook and loop strips and connect

STEP 4. FULLY OPEN FRAME

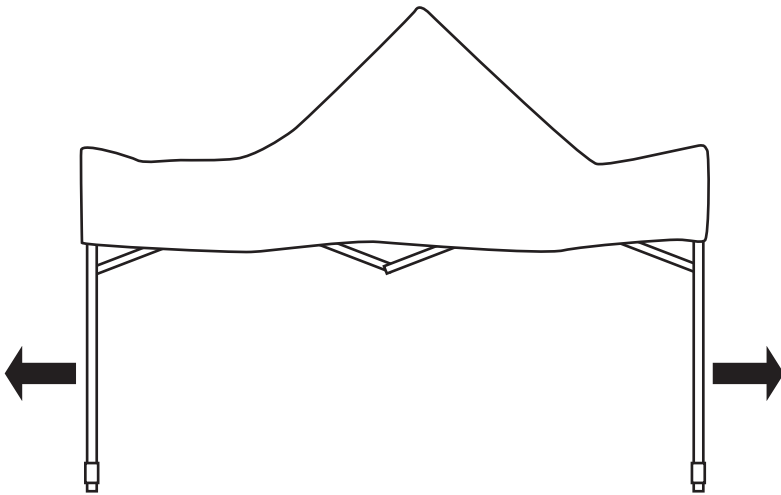

- From the same standing position, both people should now continue opening the frame to its full out stretched position

STEP 5. SLIDER FITTING

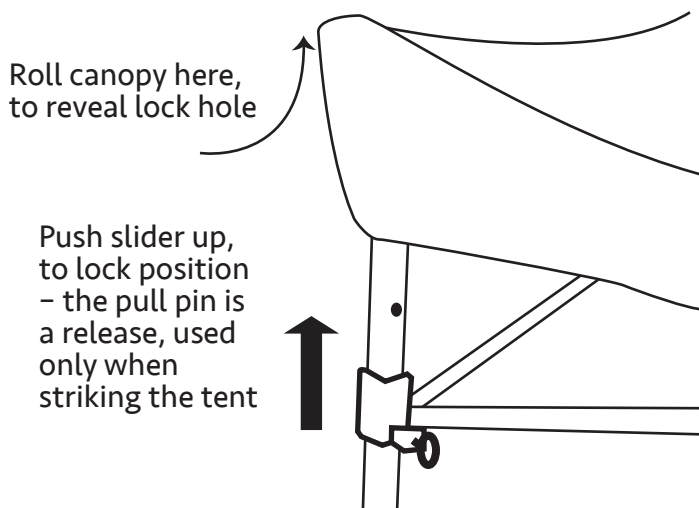

- The slider fitting locks the cross bars into place
- Start by rolling the canopy corner half-way up
- With one hand on top of leg, push up on the slider fitting with your other hand - until you reach the lock hole and hear a *click*
- Roll canopy corner back down
- Do this for all four corners

STEP 6. EXTENDING LEGS

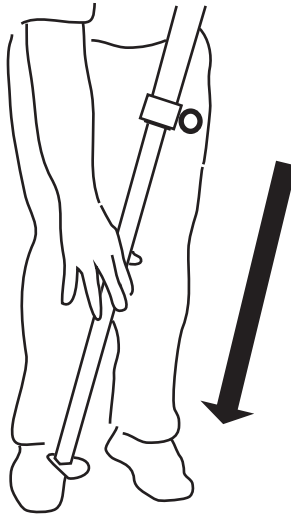

Lift top portion,
then slide lower
portion down

- Both people should move to the same side of the frame— for rectangle shaped tents, pick a long side
- At the same time lift the corner legs — two at a time
- Open quick release pin, near the bottom of leg
- Slide bottom portion of leg down to desired height and *click* into place— all legs should be same length
- Repeat for other legs— remember work as a team

STEP 7. SECURE CANOPY STRAPS

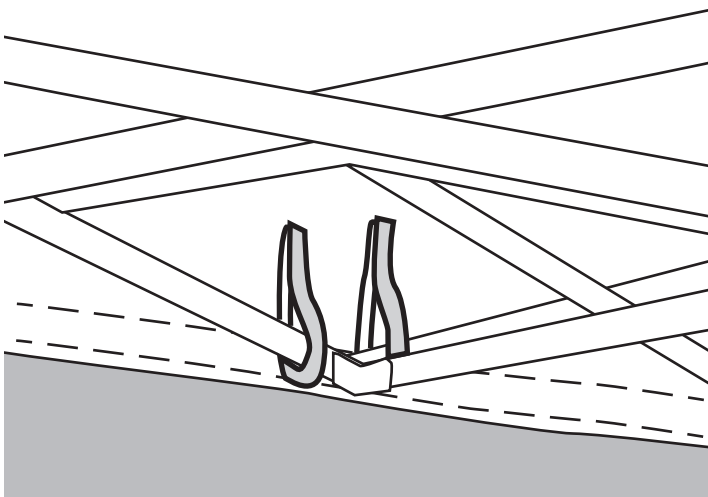

- Last step, under the canopy you will see several hook and loop straps
- It is very important to secure all of these straps— needless to say, this will secure the canopy to the frame

FINISHED TENT

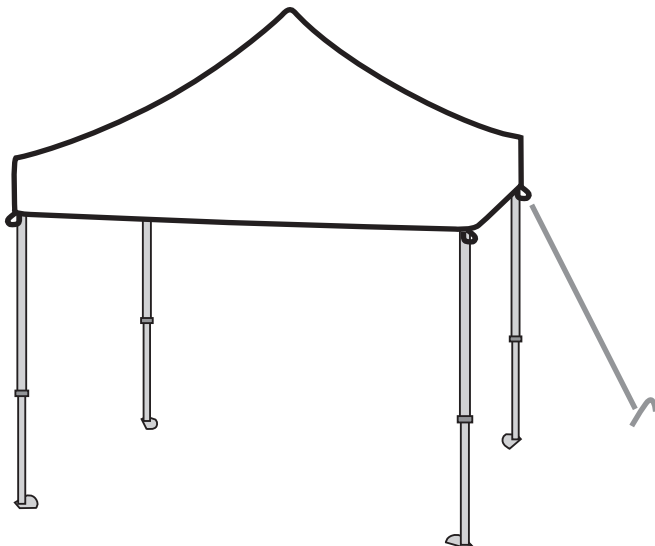

- Make any last minute location moves — by lifting tent with one person on each leg
- Anchor tent with ropes, ratchet straps or sandbags

STRIKE PROCEDURE (reverse of assembly)

—make sure tent is dry, for storage—

- 1.) Two people; quick release lower legs— two at a time
- 2.) Roll canopy corners up, release slider fittings (push up on nearest cross bar)
- 3.) Grasp upper diamond of center cross bar—walk towards center—STOP at 3/4s closed
- 4.) Change hand positions to outside of legs and finish closing
- 5.) Bag tent for storage

Speedy-Easy Up Tent Parts (50mm):

Please contact us if you have issues with your Speedy Tent. You can identify all parts involved here – making communication about your request easier. (call sales rep. for 40mm parts issues)

SPEEDY TENTS (50mm ONLY)

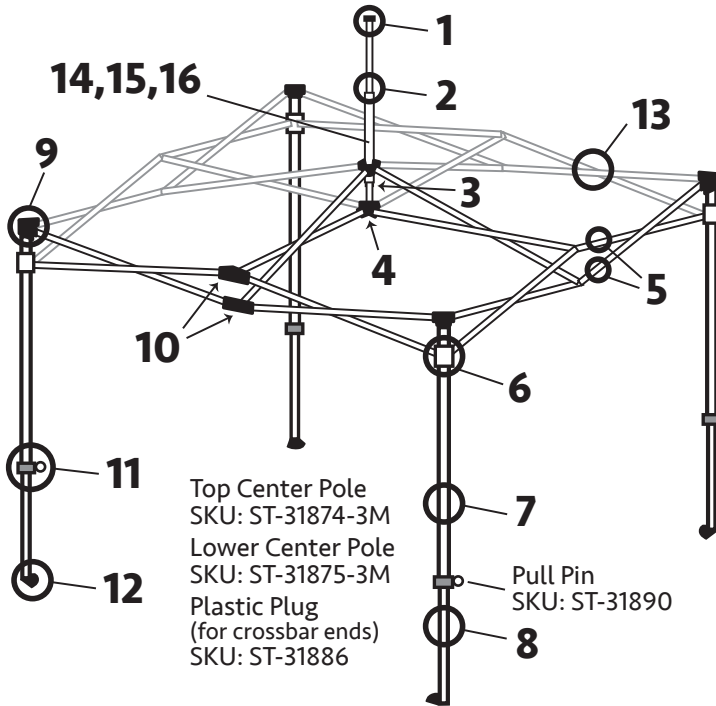

Top Center Pole
SKU: ST-31874-3M
Lower Center Pole
SKU: ST-31875-3M
Plastic Plug
(for crossbar ends)
SKU: ST-31886

Pull Pin
SKU: ST-31890

- 1.) Center Pole Cap
SKU: ST-31888
- 2.) Center Pole & Cap
SKU: ST-31873-3M
- 3.) Plastic Washer
SKU: ST-31889
- 4.) Center Pole Bracket
SKU: ST-31877
- 5.) Crossbar Pair
SKU: ST-31876-3M
- 6.) Corner Leg Pull
Pin Bracket
SKU: ST-31879
- 7.) Outer Upper Leg
SKU: ST-31870-3M
- 8.) Inner Lower Leg
SKU: ST-31872-3M
- 9.) Corner Leg Top Joint
SKU: ST-31878
- 10.) Upper & Lower
Crossbar Joint
SKU: ST-31883

- 11.) Leg Middle Pull
Pin and Bracket
SKU: ST-31880
- 12.) Steel Foot (50mm)
SKU: ST-31884
- 13.) Crossbar Hardware
SKU: ST-31885
- 14.) Large Spring (center pole)
SKU: ST-31891
- 15.) Small Spring (center pole)
SKU: ST-31892
- 16.) Plug for Spring
SKU: ST-31893

**Complete Frame
10 x 10 (50mm)**
SKU: ST-1150F
Canopy SKU: ST-1150TT

**Complete Frame
10 x 20 (50mm)**
SKU: ST-1250F
Canopy SKU: ST-1250WTT

13x26 SPEEDY TENT (50mm ONLY)

(specific to this size)
Refer to the list above
for remaining parts

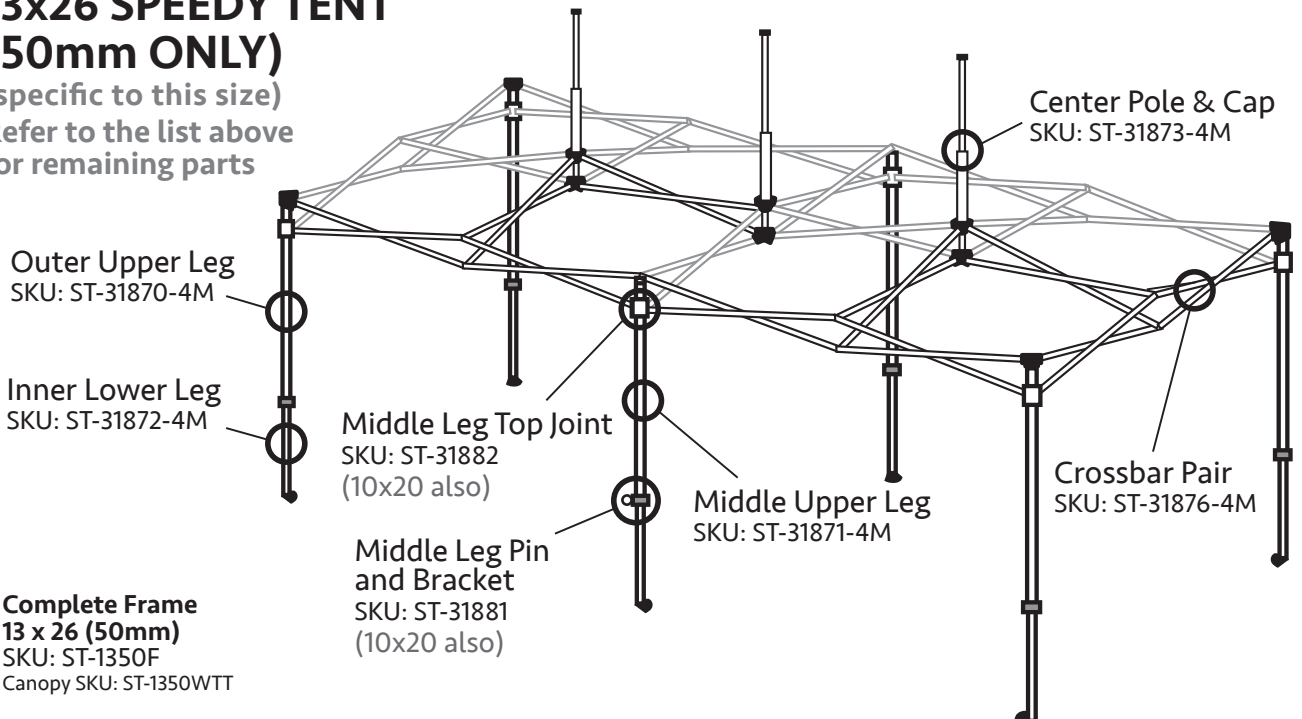

**Complete Frame
13 x 26 (50mm)**
SKU: ST-1350F
Canopy SKU: ST-1350WTT

Middle Leg Top Joint
SKU: ST-31882
(10x20 also)

Middle Leg Pin
and Bracket
SKU: ST-31881
(10x20 also)

Center Pole & Cap
SKU: ST-31873-4M

Outer Upper Leg
SKU: ST-31870-4M

Inner Lower Leg
SKU: ST-31872-4M

Middle Upper Leg
SKU: ST-31871-4M

Crossbar Pair
SKU: ST-31876-4M