

# WEST COAST FRAME TENT

# 15' x 30'

## ASSEMBLY INSTRUCTIONS



## West Coast Frame Tent (OVERVIEW)

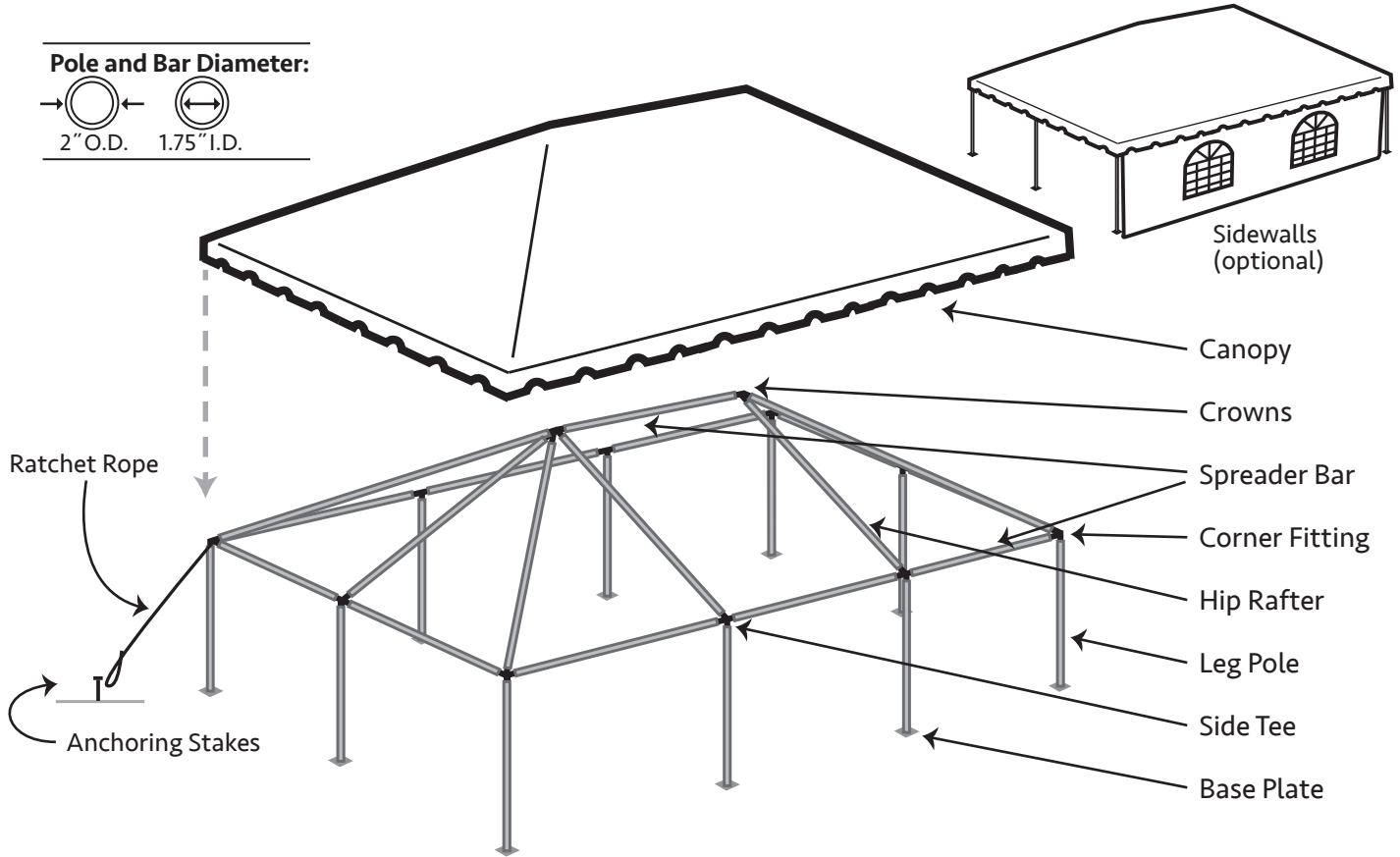









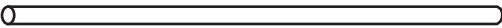

Refer to **(appendix)** for basic spreader, rafter and fitting layout

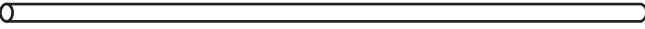
(example, not size specific)

## West Coast Frame Tent (SPECIFICATIONS: 15x30)

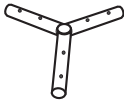
Width	15 ft. / 4.6 m	Fabric Material	PVC Coated Polyester
Length	30 ft. / 9.1 m	Fabric Material Weight	16 oz. / yd <sup>2</sup> / 540 gsm
Area	450 ft <sup>2</sup> / 41.9 m <sup>2</sup>	Fabric Translucency	Block-out
Eave Height	7' / 2.1m (opt. 8' / 2.4m)	Water Repellency	Waterproof
Overall Height	10' 9" / 3.3m (opt. 11.75' / 3.6m)	Flame Resistant	Yes
Pitch	3' 9" / 1.1 m	UV Resistant	Yes
Complete Weight	306 Lbs./139Kg. (312 Lbs./142Kg.)	Mold and Mildew Resistant	Yes
Series	West Coast	Frame / Pole Material	Aluminum
Class	Frame	Longest Component	14'4" / 4.4 m
Center Pole	No	Persons required for setup	2-3
Style / Shape	Traditional Tent	Occupancy	40 Sit Down Dinner
Expandable	No (sectional tops only)	Occupancy (cont.)	75 Cathedral Seating
Custom Printing Available	Yes		

## STEP 1. CHECK ITEM LIST (15ft. x 30ft.)

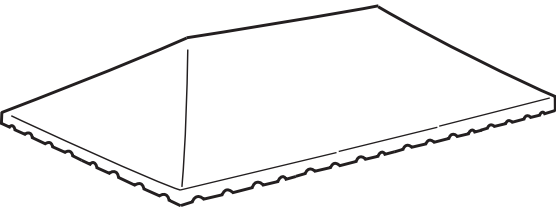
Item	Illustration (all parts available for replacement)	Size	Quantity
<b>Hip Rafters</b> (yellow/red)	<p>Size: 10'-6" (green)</p>  <p>SKU: BT-FWAST126</p>	15x30	4
<b>Rafters</b> (green/red)	<p>Size: 7'-8" (black)</p>  <p>SKU: BT-FWAST092</p>	15x30	2
<b>Spreaders</b> (white/red)	<p>Size: 14'-4" (red)</p>  <p>SKU: BT-FWAST172</p>	15x30	7
<b>Leg Poles / Base Plates</b> (black)	<p>Sizes: 6'-8" (brown)</p>  <p>SKU: BT-FWAST080</p>  <p>SKU: BT-FWBP</p>	15x30	6
<b>Corner Fittings</b>	 <p>SKU: BT-FWCRN</p>	15x30	4
<b>Side Tee Fittings</b>			none
<b>6-Way Crowns</b>			none
<b>8-Way Crowns</b>			none
<b>Ridge Crowns</b>			none
<b>(Crowns)</b>	 <p><b>3-WAY CROWN</b> SKU: BT-FW3WC 15x30 (2)</p>  <p><b>2-WAY ADJUST. CROWN</b> SKU: BT-FW2WC 15x30 (1)</p>	15x30	2 / 1
<b>Rope- 12ft.,</b> w/ loop	 <p>SKU: BT-TAROPE</p>	15x30	6
<b>'R' Pins</b>	 <p>SKU: BT-FWRP25</p>	15x30	38
<b>Single Head Stakes</b> (3/4" x 30")	 <p>SKU: BT-34SH30</p>	15x30	6
<b>Canopy Top</b>	 <p>SKU: BT-FW153WTT</p>	15x30	1
			(see appendix for more info)

## STEP 1. CONTINUED

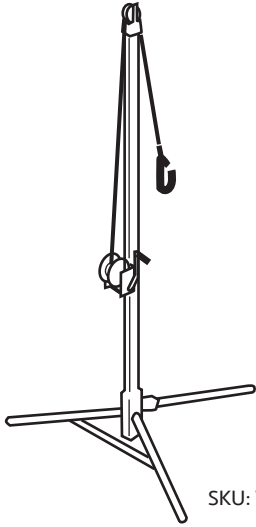

SKU: WCF-JACK-12

This item is very important in the process, **Frame Tent Jack** (sold separately). Some West Coast Frame tents require *frame tent jacks*—and larger tents require multiple jacks.

General rules are; work on the long side, one side at a time, and never place jack in the middle of a spreader bar.

(set-up and use can be found on internet)

Tent Size	Estimated Quantity
10 x 10	none
10 x 20	none
15 x 15	none
15 x 30	2
20 x 20	none
20 x 30	2
20 x 40	3
20 x 60	4

### Recommended Tools

- 6ft. step ladders
- Sledge Hammer
- Tape Measure
- Work boots
- Stake Driver (for larger tents)

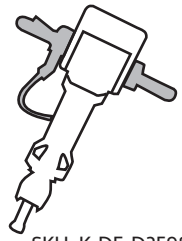

SKU: K-DE-D25980K

## WARNING

Tent products are manufactured for use as temporary structure and do not meet structural code, unless specified. Since weather is unpredictable, the customer must incorporate their own good judgment, common sense & knowledge of local conditions with the installation instruction guidelines.

The customer is responsible to anticipate weather severity for proper time and method of construction.

## 'BEFORE YOU DIG' (hammer stakes)

By Law you are required to contact your local "Call before you dig" number before you plan to dig. After calling, your local utility company will mark the location of underground utility lines. Laws from state to state vary on how far in advance you must call.

Planning ahead and checking with your state's program is always a smart idea. Failure to obtain a line location before digging can result in a substantial fine. Please find your local "call before your dig number" by going to [call811.com](http://call811.com).

## STEP 2. SAFETY CHECK LIST



- When building or assembling anything above shoulder height, wear a hard hat
- Steel toe boots are recommended
- Inspect the site, look for overhead and underground obstructions— such as utilities
- Call your local utility to have utility lines marked (call 3–5 days ahead)— [call811.com](http://call811.com) is a good resource— 'click' 811 in Your State
- Inspect all ropes and tie lines
- Inspect poles, making sure there are no bends or breaks
- Replace or repair any items in poor condition

### STEP 3. LAYOUT FRAME

Position parts in the exact location of finished tent

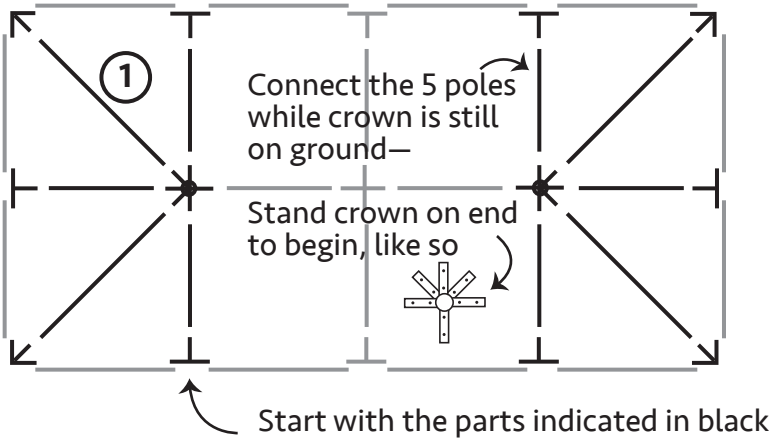

- Place all tent poles and fittings on the ground in the location you have selected for the finished tent
- This layout illustrates a 20 x 40 tent — see (**appendix A**) for your specific size, layout and pole sizes
- 1) Start with the crown and its connecting poles—the drawing shows the correct position of the crown—secure these parts using (2) 'R' pins per pole
- See (**figure A.**) for 'R' pin usage
- Stand these two end assemblies up, to connect the ridge parts next

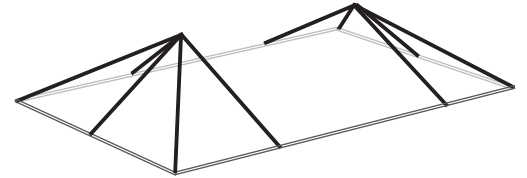

### (FIGURE A.) 'R' PIN AND ALIGNMENT HOLE

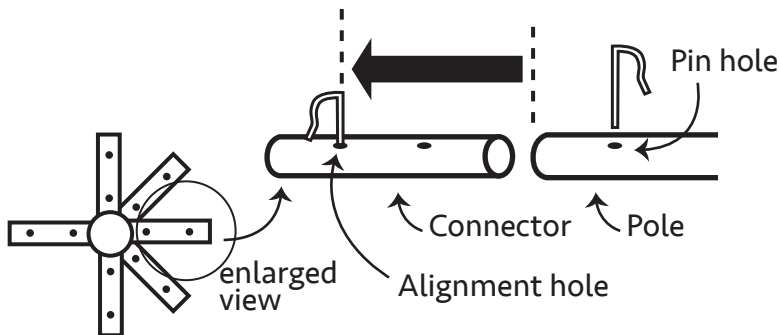

- All connection will be made using this method—2 pins needed
- Insert a pin, halfway, into the alignment hole—this will act as *stop*, for spreader and rafter bars
- Slide pole (spreader, rafter etc.), onto the appropriate connector—touch the *alignment pin*, as a guide
- The pin holes are now lined up—insert the second 'R' pin, all the way, until it locks in place

Reminder:

Frame plans and connector positions, for your tent, appear in the appendix

### STEP 4. RIDGE AND PERIMETER

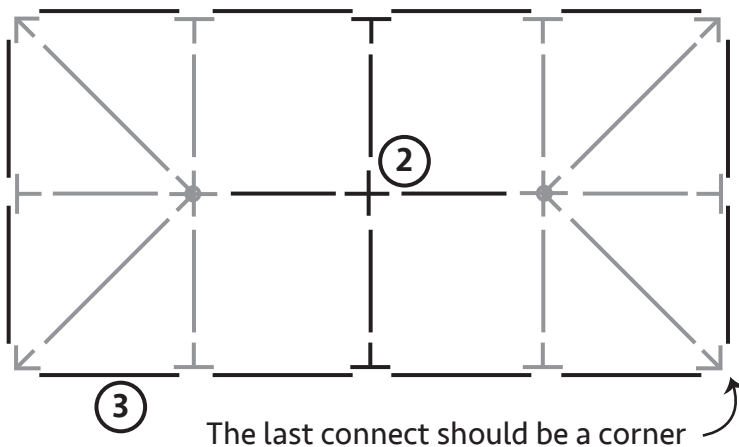

- 2) Connect the ridge line next (15x30 or larger), crowns and spreaders
- While standing on a ladder(s) make all connections from end to end
- If you are short of people, use a tent jack to hold horizontal poles
- 3) Lastly, connect all perimeter bars to the upper spreaders and rafter bars
- When working around the perimeter, the last connection should be at a corner, *not* a side tee
- The frame should now be complete

(example, not size specific)

### STEP 5. COMPLETED FRAME

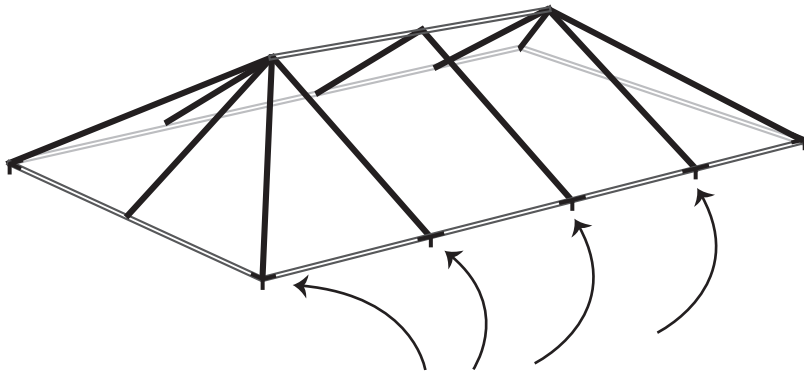

If repositioning is necessary, try to have one person lift at each fitting, all the way around

(example, not size specific)

- Now that the frame portion is complete and while the frame is still on the ground, double check the 'R'-pins
- Also, with plenty of hands on deck, lift and adjust frame position if needed, at this point
- Always lift at a side or corner fitting

### STEP 6. ANCHOR ROPES

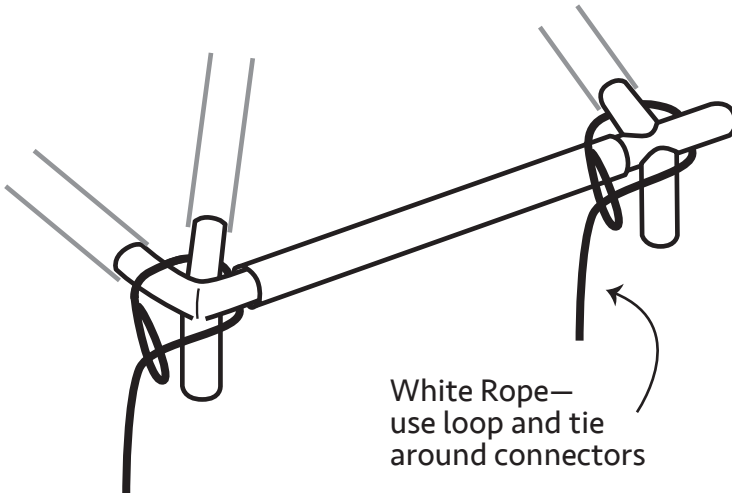

White Rope—  
use loop and tie  
around connectors

- While frame is still on the ground, tie anchor ropes to the frame
- The ropes will be secured to the tent stakes at the end of the assembly
- One rope per leg pole
- The ropes go under and over, to prevent them from sliding away from leg—see (**drawing**)

Note: this step can occur after the leg poles have been installed and the frame is elevated

### STEP 7. CANOPY

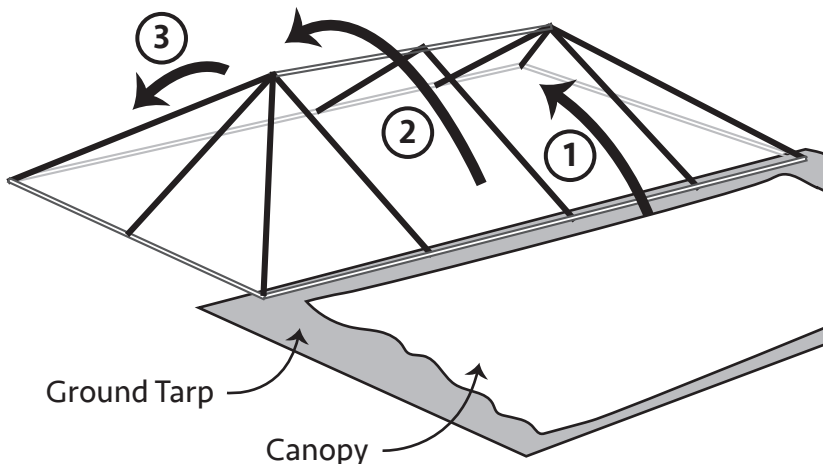

Ground Tarp

Canopy

- Once again, while frame is still on the ground, lay down a tarp(s), to protect canopy—arrange canopy along one of the long sides of the tent
- Place a ladder(s) next to ridge spreaders —as many as it takes to easily to pull canopy over ridge
- One person needed for every 10ft of tent
- 1) In unison, pull canopy up one side—'flapping' in the beginning, to create lift—then stop
- 2) Have most people stay on the ground, and a couple people on ladders—pull canopy over the ridge
- 3) Pull down the other side—'flapping' for all three steps

### STEP 8. CANOPY CORNERS

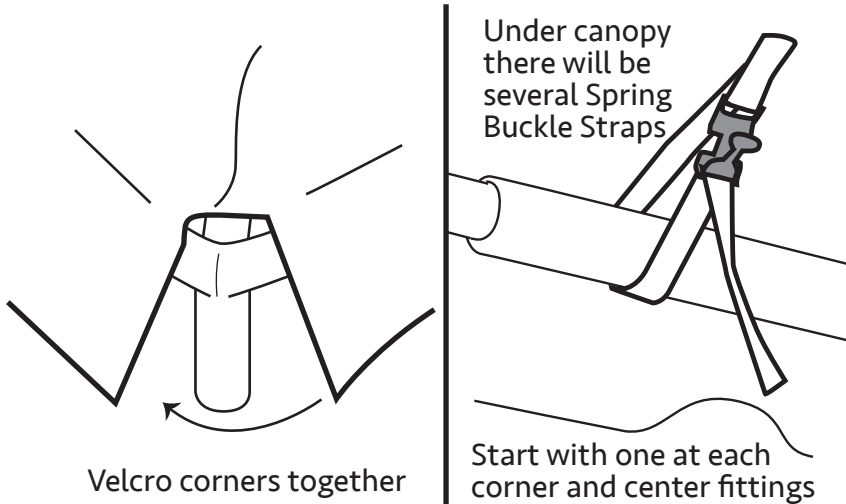

- After canopy is pulled over frame and corners are pulled into position, velcro corner seams together, loosely—tighten after legs are installed
- The canopy should be attached to the frame, before legs are connected—secure some of the spring buckle straps, to keep canopy in place—start near corners and center fittings
- Spring buckle straps are located on the underside of canopy
- Secure the remaining straps after legs are installed on one side and secure—it's easier at this height—Final tightening happens after legs are installed (**step 10**)

### STEP 9. BASE PLATES

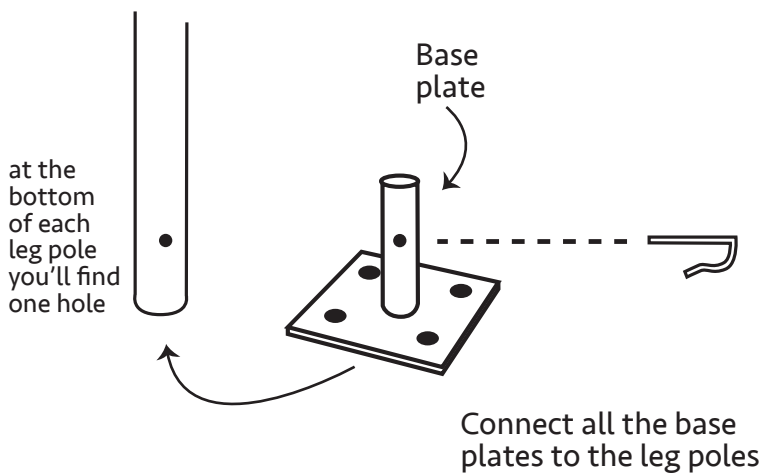

- Before the tent is raised, prepare the leg poles
- Place poles on top of base plate and secure with 'R' pins
- Do this for all the leg poles

### STEP 10. INSTALLING LEGS (smaller tents)

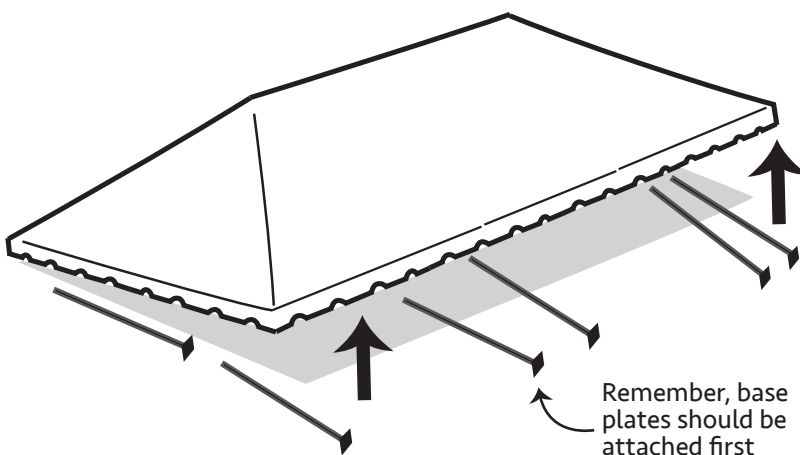

- For smaller tents, (10x10, 10x20, 15x15, 20x20) three or four people should be able to raise the frame and install the leg poles
- Locate one of the long sides of the frame—this will be raised first, while the opposite side remains on the ground
- **Important:** Lift the entire side of the frame at once (not one corner)
- Install all the legs on this side—secure with 'R' pins—
- Repeat for opposite side, then install legs for the remaining two sides
- *Double check the canopy corners—pull them down tight and straight*
- **Important:** tighten spring buckle straps—for security and to help pull canopy corners into place

### STEP 10. INSTALLING LEGS (15x30 and larger tents)

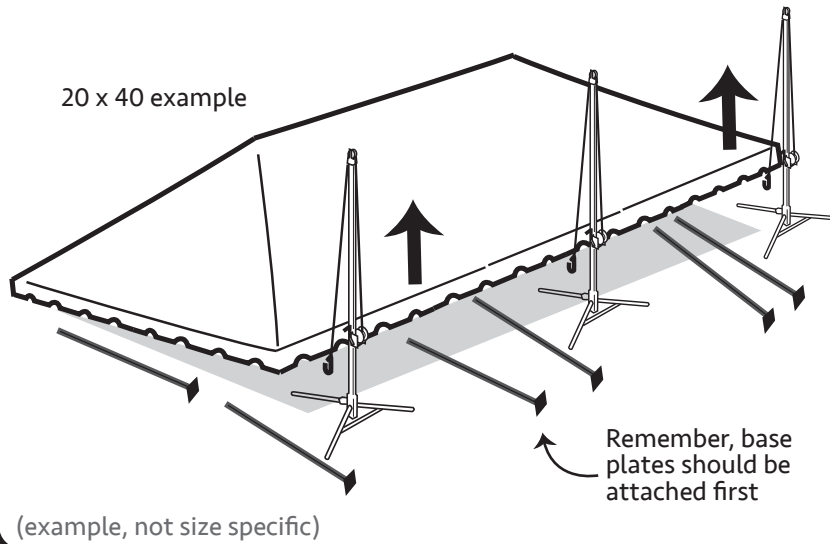

- For larger tents, (15x30 and larger) frame tent jacks should be used to raise the frame and install the leg poles
- Locate one of the long sides of the frame—this will be raised first, while the opposite side remains on the ground
- **Important:** Lift the entire side of the frame at once (not one corner)—crank jacks in unison
- General rules are; work on the long side, one side at a time, and **never** place jack in the middle of a spreader bar*
- Install all the legs on this side—secure with 'R' pins
- Repeat for opposite side, then install legs for the remaining two sides
- **Important:** tighten spring buckle straps—for security and to help pull canopy corners into place

### STEP 11. STAKE LINE

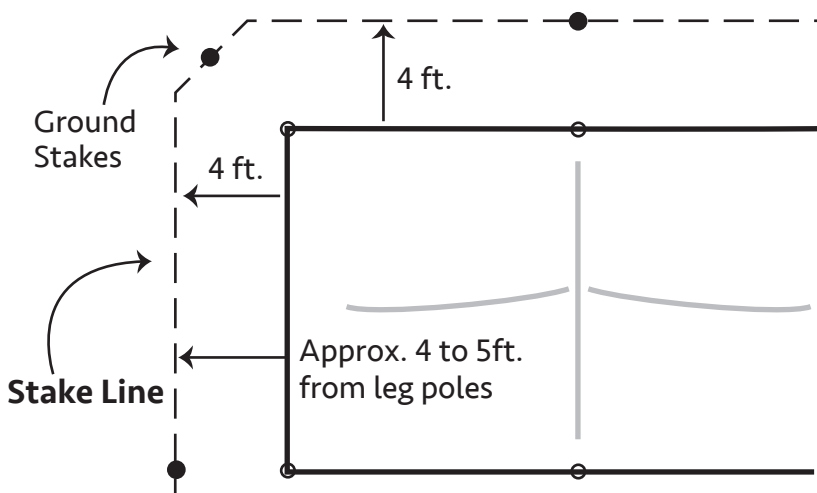

- **Double check leg poles**—making sure each pole is straight and lined up correctly, while tent jacks are still handy
- Once the tent is vertical and all the leg poles are attached, begin the process of staking the tent—with plenty of hands on deck, lift and adjust tent position if needed, first
- Measure 4 ft. out from each leg pole and place a stake in the ground
- Stakes should look uniform, around the tent—and 6 inches above ground see (figure B)
- Stakes should then be hand hammered or for larger installs, use a stake driver

### (FIGURE B.) HAMMERING STAKES

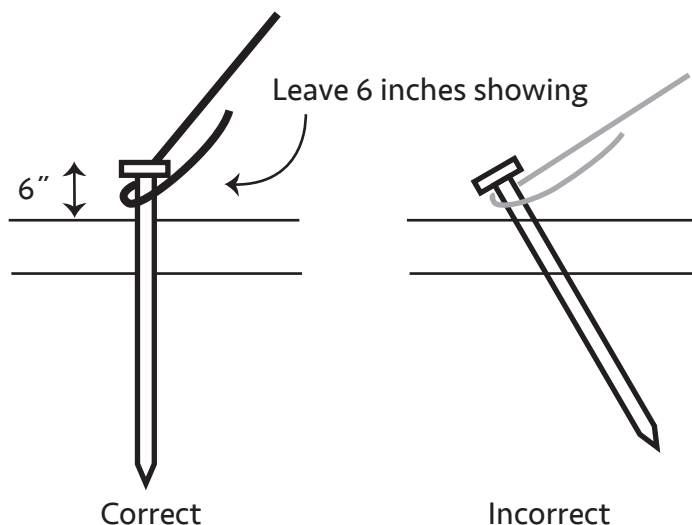

- Ground stakes should be hammered in vertical, not angled (sledge hammer required)
- Complete the hammering process by driving the stakes in and leaving 6 inches showing
- Connection of ropes to ground stakes, can be made with a few different secure knots (see figure C, page 8) for one of the more commonly used knots



### STEP 12. SECURING ROPES

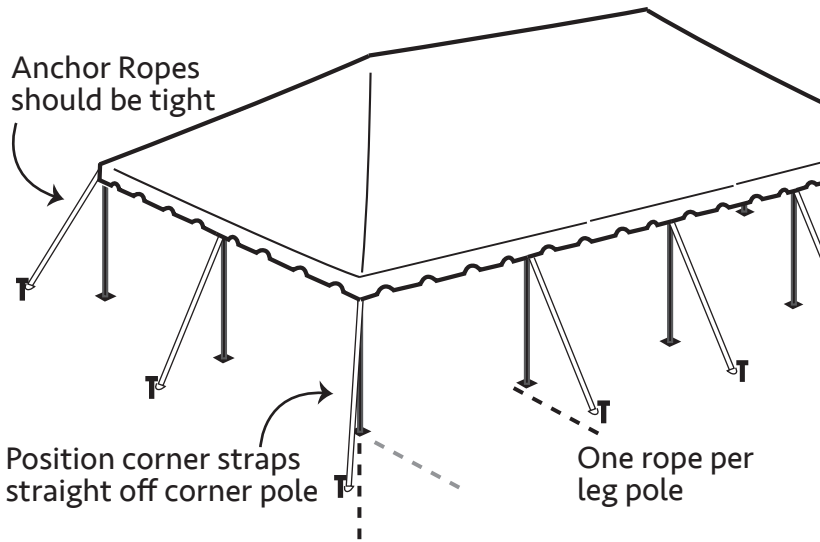

- As the assembly nears completion it is time to tighten all ropes/ratchet straps
- Keep an eye any lean that might be caused by the tightening process
- Go around the tent, make adjustments for any leg pole and tent lean
- Smaller tents use ropes to secure the tent to the stakes— see (figure C)
- Finally, secure any remaining spring buckle straps, under the canopy, that were not secured in step 8

### (FIGURE C.) CLOVE-HITCH KNOT

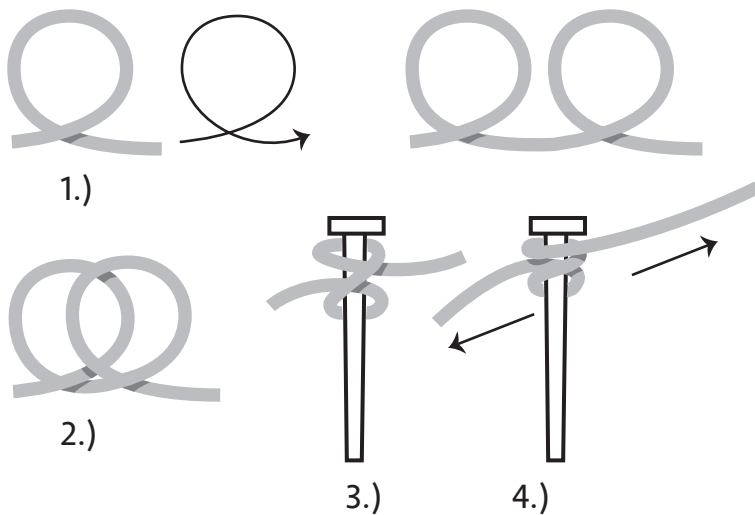

- A commonly used knot for securing a rope to stake is the *clove-hitch*
- 1.) Make two loops
- 2.) Cross loops by placing second loop over the first
- 3.) Place the combined loops over stake  
Option: loops can be form directly on stake
- 4.) Pull on both ends to tighten rope  
Note: outward force tightens and inward force loosens the knot—when making adjustments
- 5.) Excess line should be pulled half-way up the rope and tied off

### FINISHED TENT (15x30)

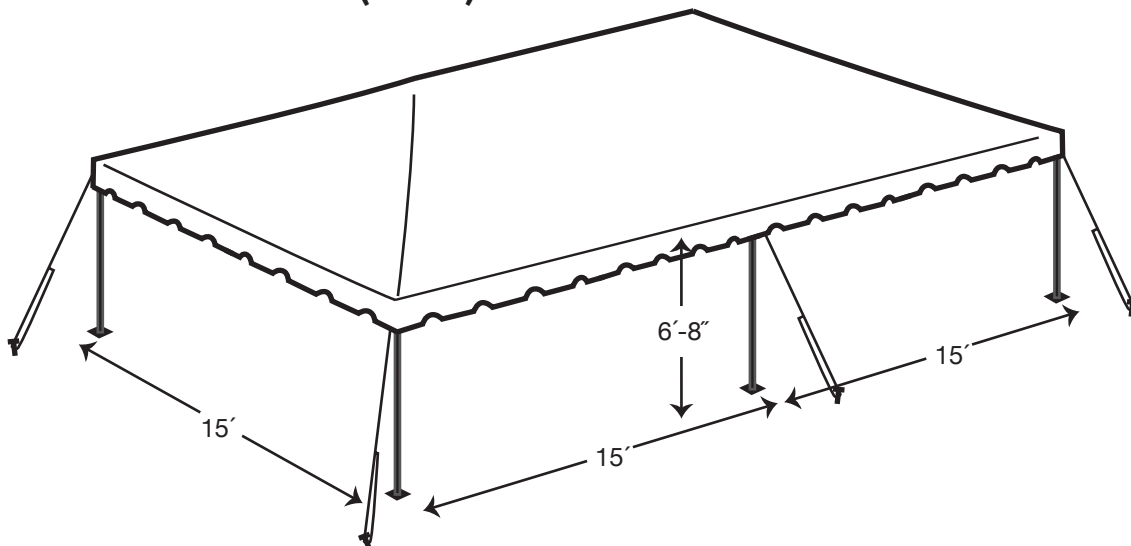

## WIND AND RAIN – IMPORTANT INFORMATION:

### WIND!

Wind can cause the ratchet assemblies and stakes to loosen, or cause the poles to **sink** or shift through constant movement and vibration – the tension of the tent will be negatively altered.

### Follow these steps to provide extra security and safety during windy conditions:

- Very important, do routine maintenance checks – be sure to check proper tension regarding the ratchet assemblies, throughout the day/event. This is critical, if your tent must stay up, in moderate windy conditions.
- In the case of strong winds, remove any sidewalls. This will allow the wind to pass through the tent, diminishing major upward pressure on the tent top.
- Additional security can be achieved by adding additional stakes and ropes/straps to corners— and to the 'wind side' of the tent.
- When anticipating windy conditions, perform a **soil test** to determine proper staking:
  - 1.) drive a large steel stake approx. 20 in. into soil, vertically
  - 2.) measure the distance from the ground to the top of stake
  - 3.) with a 16lb. sledge hammer, strike stake with an average blow (don't over hit)
  - 4.) measure the **movement**/hold strength: (**0.2in./2500lbs**) (**0.3-.5in./1600lbs**) (**0.6-1.5in./800lbs**) (**1.6-3in./400lbs**) (**3-6in./200lbs**) (**> 6in./100lbs**) Double or triple staking might be necessary, 10in. behind primary stake (see figure D). [search web for: **tent.IFAI tent staking handbook** for detailed information]
- When SEVERE WEATHER is approaching, the TENT SHOULD BE EVACUATED— and TAKEN DOWN!

### • Proper Setup Note:

Make sure all poles are vertical and form a 'squared up' rectangle.

30 wide and larger: use a *Mason's string* – attach at the base of one corner pole, go around all 4 corners to form a box. Tighten the string – then align all side poles by having them touch the string. Proceed by bringing these poles vertical and applying proper tension to each strap – start at the middle of one of the short sides (2 people, same speed) and work around the tent, ending with the middle of the other short side (see figure E). **The person on the 'wind side' goes first.**

Lastly, re-check the corner poles.

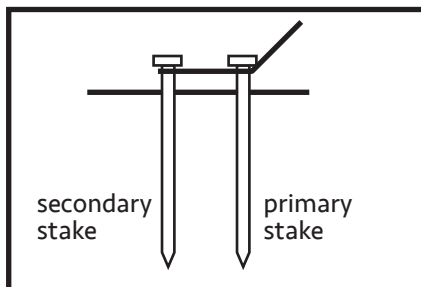

D.

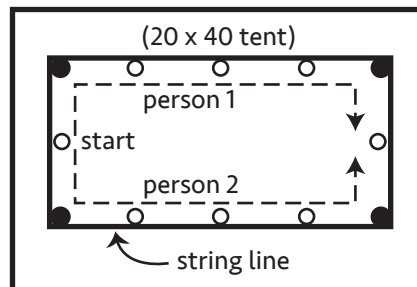

E.

### RAIN!

When rainwater collects on the tent canopy it causes 'ponding'— occurring in heavy weather conditions. If the tent is not tensioned correctly, this issue will be made worse. Additional weight from the water will cause the tent to sag – this may cause the poles and base plates to sink into the soil. In addition, water saturated soil will cause the stakes to lose their holding power. When you combine loosened stakes, added weight on the canopy and reduced tension on ratchet assemblies, the structure becomes a **safety hazard**. IT IS THE TENT OWNERS RESPONSIBILITY TO ASSURE THE SAFETY OF ALL INVOLVED.

## STRIKE PROCEDURE (basically, reverse order from assembly)

- 1.) Undo ratchet strap assemblies/untie ropes
- 2.) Unfasten spring buckle straps, under canopy
- 3.) Remove leg poles, on one long side  
(use tent jacks for larger tents)
- 4.) Remove adjacent center, leg poles, on short sides
- 5.) Lower first long side to the ground
- 6.) Repeat, remove leg poles, on remaining long side
- 7.) Lower rest of frame to ground
- 8.) Lay tarp next to a long side of frame
- 9.) Loosen canopy corners
- 10.) Slowly slide canopy off frame—flapping, in unison, as you go
- 10.) Fold and bag canopy (dry canopy)
- 11.) Disassemble poles and connectors
- 12.) Remove ground stakes

### Folding Canopy:

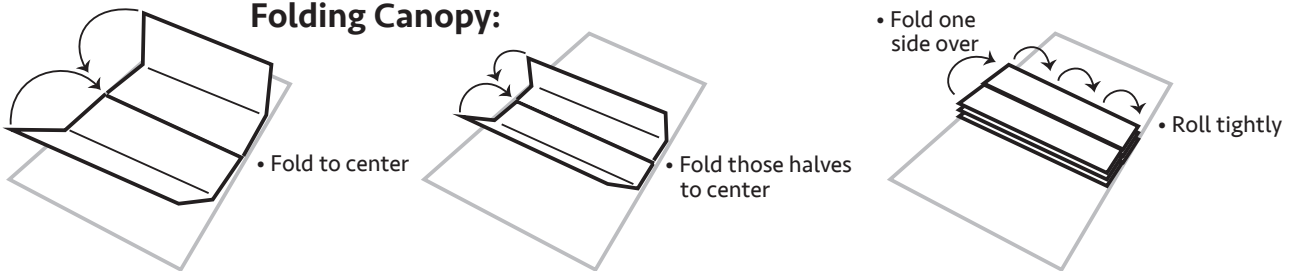

### USING RATCHET STRAPS

(Ratchet Buckle Components)

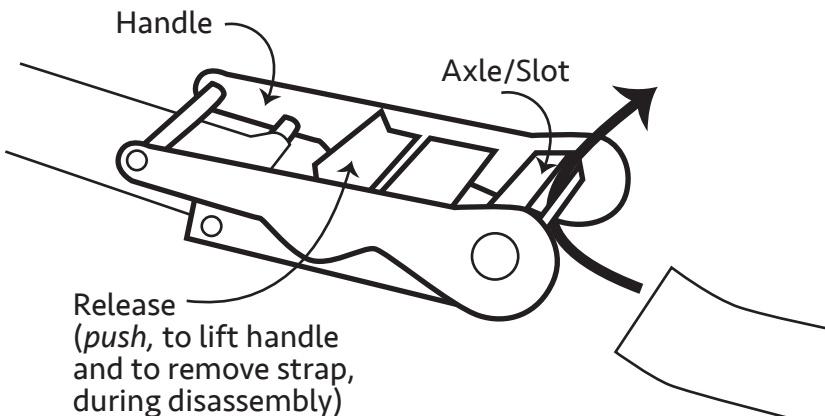

- Release handle, crank until slot is pointing up
- Close handle
- Pass strap underneath and through the slot (as shown)
- While holding the whole strap assembly attach both ends (eg. tent to stake)
- Remove slack, before tightening
- Push 'release'— lift handle and tighten ratchet
- Roll-up any excess strap, put under handle
- Close handle

# Appendix A.

- Tent Plan— showing details (spreader/rafter reference below)

## 15X30 TENT

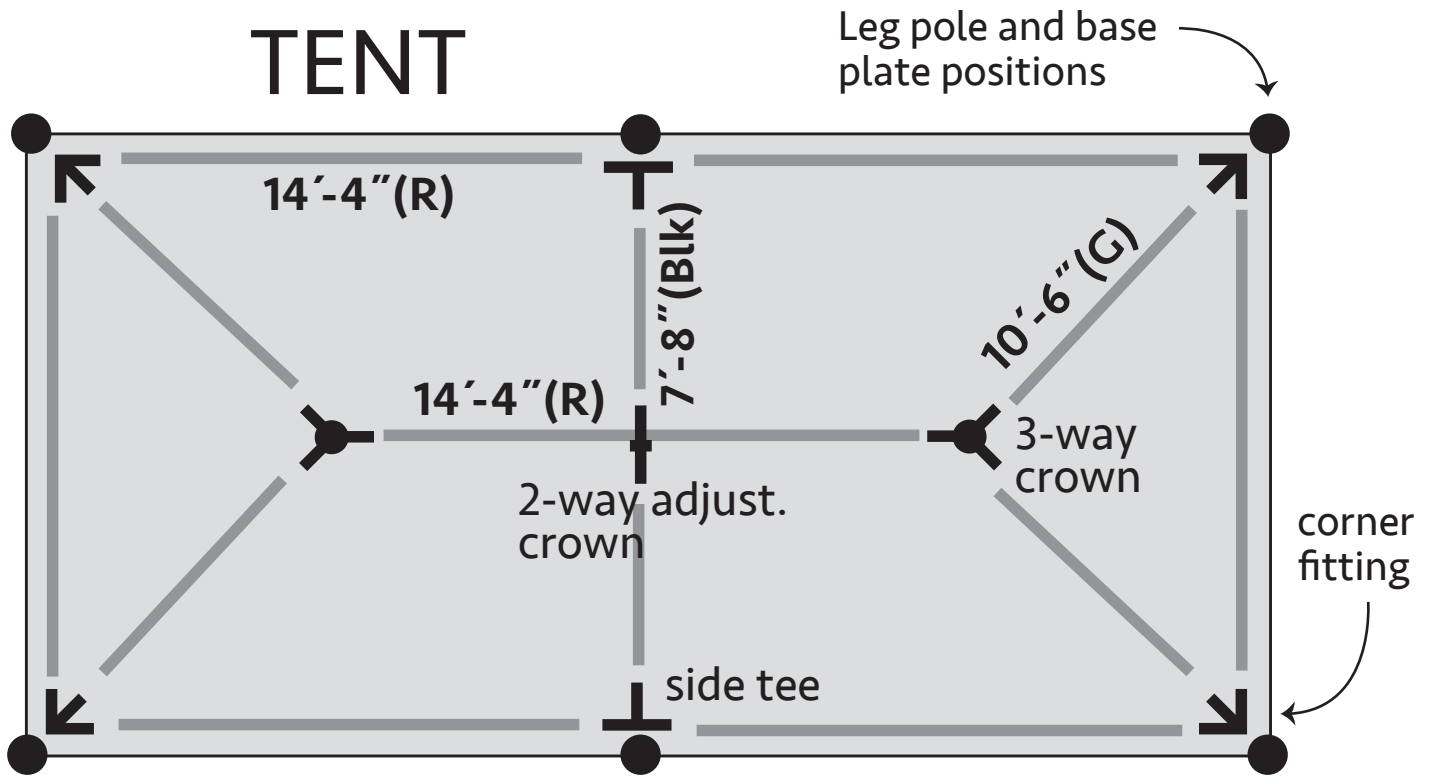

(7) spreaders-r (4) hip rafters-g (2) rafters-blk

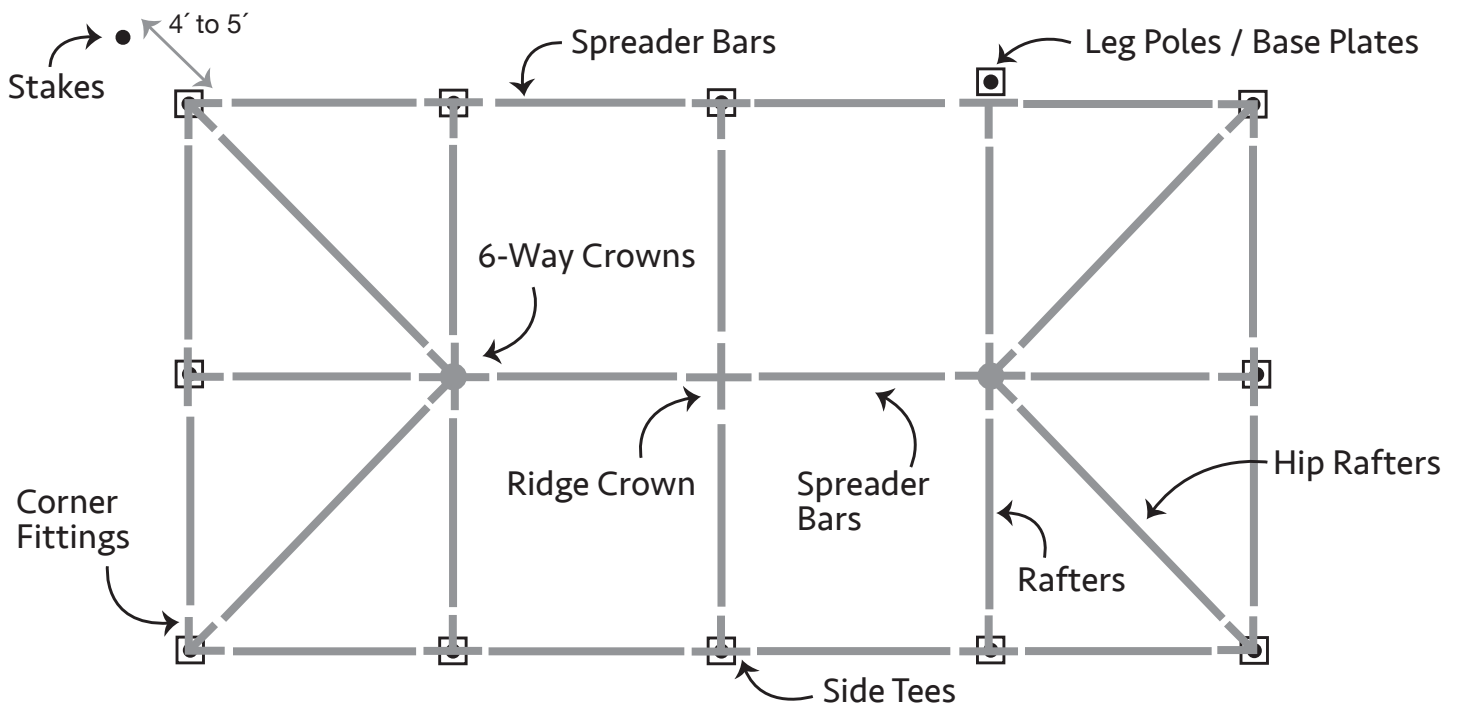

(example, not size specific)