

INSTRUCTION MANUAL

Interactive Games

GENERAL INSTRUCTIONS



INTERACTIVE GAMES – OVERVIEW

OPERATOR/ATTENDANTS ARE RESPONSIBLE FOR THE PATRONS SAFETY, AT ALL TIMES!

GFCI extension required (reduces possibility of shock)

Keep individuals OUT of blower areas, at all times

2 trained operator/ attendants are required to supervise this device, at all times

Use Ground Cover Tarps (to protect inflatable)

Must be positioned on a FLAT, LEVEL SURFACE

Anchor Straps at base—secure with recommended stakes (refer to your state inspection requirements)

Commercial Inflatable Blowers needed 1.5 HP / producing minimum 700 cfm @ 4.5" (consult manufacturer's safety label for requirements)

CHECK ALL SPECIFICATIONS LOCATED ON SAFETY LABEL- ATTACHED TO YOUR UNIT

SET-UP STEP 1. (SAFETY CHECK LIST)

- WARNING:** Inflatables are very heavy—do not attempt to roll or move these games by yourself
- Do not inflate in high winds or rain—High winds are considered to be **15 mph** or higher
 - Inspect the site, look for overhead and underground obstructions—such as utilities
 - Call your local utility to have utility lines marked (call 3-5 days ahead)—**call811.com** is a good resource—'click' 811 in Your State
 - Use an adequate three wire extension cord, min. 12 gauge for 50ft. maximum length—never cut or remove the round grounding pin from the cord

SET-UP (SAFETY CHECK LIST - cont.)

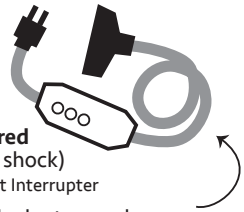

GFCI extension required
(reduces possibility of shock)
GFCI= Ground Fault Circuit Interrupter

- A GFCI extension cord adapter can be purchased at most Do-It-Yourself type stores
- Use an adequate three wire extension cord, min. 12 gauge for 50ft. maximum length
- Check GFI at least once per event

- Always connect a GFCI extension cord adapter to any extension cord before plugging into a power source—this reduces the possibility of shock in wet environments
- Check the GFCI operation at least once per event
- Before staking unit into the ground, obtain marking and location information from the utility companies if there is a possibility of striking underground utilities
- Remove all occupants if wind becomes excessive—deflate unit, if wind continues
- Important**, the operator/attendant is responsible for the safety of those using the inflatable amusement device

SET-UP STEP 2. (SITE ASSESSMENT)

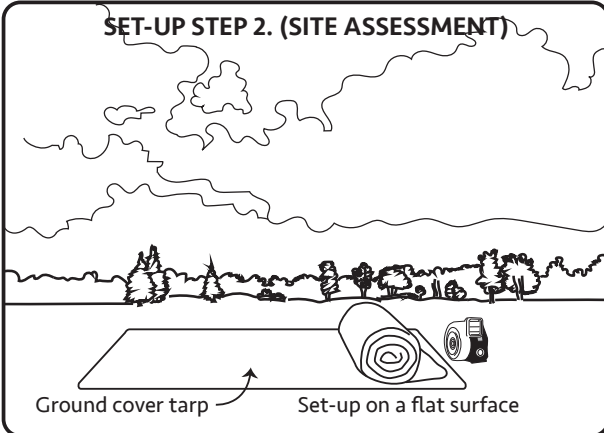

- Pick a location free from overhead utility lines, trees, roads, sidewalks, bodies of water and cliffs—or any hazard
- Any nearby obstruction should be at least 20 feet away from inflatable
- Spread tarps (sold separately) on the slide/bounce house location, to protect unit
- Locate the blower and power cord in an area that is not in a direct walkway—be sure the blower is on a flat and dry surface
- A minimum of 2 installers recommended

Recommended Tools and Equipment:
sledge hammer, ground tarp, hand truck or 4 wheel dolly, crowbar/stake remover safety goggles, GFCI extension adapter, 50' 12AWG extension cord

SET-UP STEP 3. (UNROLL AND POSITIONING)

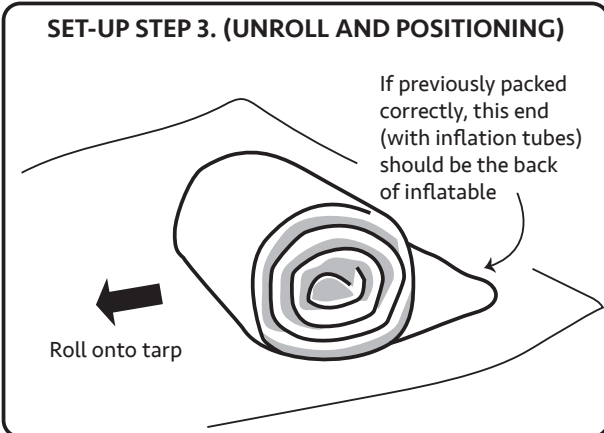

If previously packed correctly, this end (with inflation tubes) should be the back of inflatable

Roll onto tarp

- Carefully place unit, using dolly, at one end of tarp—it's easier to move at this stage!
- See (drawing), find back end of inflatable device and roll onto tarp
- (Make a mental note or snap a picture of how the inflatable is folded and positioned as you unroll the game. This will be beneficial when you re-roll the device later)
- Check location, make any adjustments before inflation—unfold device completely
- Start the staking process—place stakes through the inflatable anchor straps, all around the inflatable amusement device—see (pg. 3) for proper staking

SET-UP STEP 4. (INFLATION TUBES)

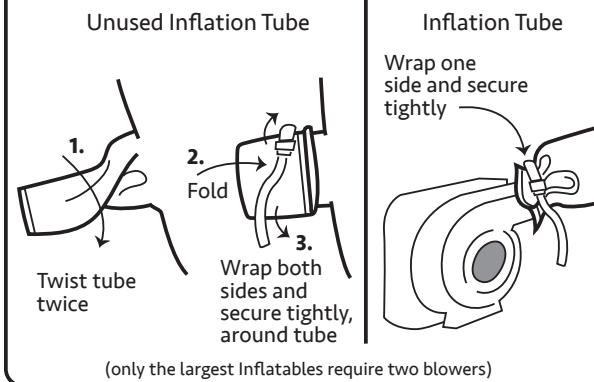

(only the largest Inflatables require two blowers)

- Plug the blower power cord into the GFCI extension, then plug the GFCI extension into the extension cord—connect the fan cone to the inflation tube
- Close off the unused inflation tube(s)
- Plug the extension cord into the power source
- Check the inflation tube to make sure it is properly attached to the blower fan—the inflation tube must be properly closed around the blower outlet chute for maximum inflation during use
- Close all zipper vents (if applicable)

Note: AIR ESCAPING FROM SEAMS is normal, during the operation of unit—it keeps the unit inflated, but not over filled (air should be escaping during use)

SET-UP STEP 5. (PROPER STAKING)

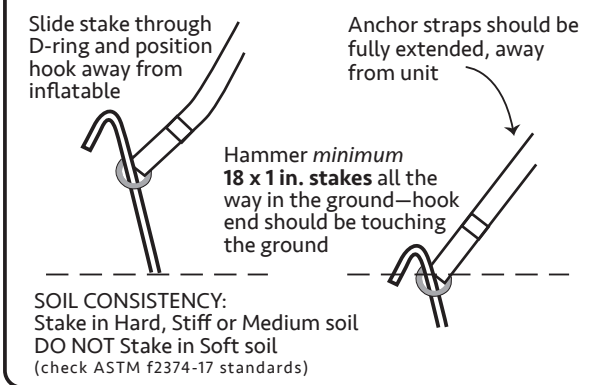

SOIL CONSISTENCY:
Stake in Hard, Stiff or Medium soil
DO NOT Stake in Soft soil
(check ASTM f2374-17 standards)

- Locate the on/off switch (if applicable) on the blower and turn it on—observe the inflation of the inflatable as it rises
 - When inflation is almost finished, check the positioning of the stakes—hammer them all the way in—see (step 5)
 - Note: For medium soil conditions, larger stakes will increase pullout capacity*
 - When properly inflated, all inflated areas of the game will become pressurized and firm
 - Once inflated, check for any rips, holes, or damage—'walk-around' during use
- Important: Keep blower on, continuously, for the duration of your event—to maintain proper inflation**

OPERATING INSTRUCTIONS



The following instructions must be read and adhered to by all operator/attendants regarding this inflatable device:

- Trained attendants should be positioned at the entrance and exit of device
- Attendants must be at least 18 years old
- Trained operator/attendants should assist the movement of all child patrons as they enter and exit the amusement device
- Attendants should remove all debris from the inflatable prior to allowing persons to enter or climb on inflatable
- Trained attendants should only allow persons of the same size and age on the inflatable device at the same time—(check capacity on device warning label)

OPERATING INSTRUCTIONS - cont.



No Sharp Objects



No Running—to Enter



No Food or Drink



No Chewing Gum



No Cell Phones



No Loose Objects in Pockets

- People with medical conditions or severe disabilities should not use this inflatable amusement device
- Attendants should make sure that no one enters the inflatable device with **shoes** on, eyeglasses or sharp objects in their hair or on clothing
- Attendants should observe patrons at all times while they are in the inflatable
- Attendants should be close enough to be able to warn against flips, piling on, wrestling, bouncing against side, grabbing net or bouncing too close to each other—attendant should ask anyone doing these things, after being warned, to leave the inflatable device immediately
- Whistle use required for attendants
- No running to enter the inflatable device

OPERATING INSTRUCTIONS - cont.

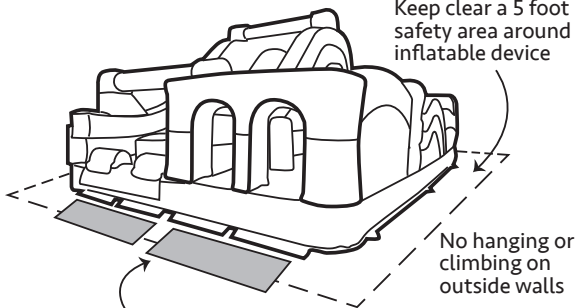

Keep clear a 5 foot safety area around inflatable device

No hanging or climbing on outside walls

ASTM Int'l guideline calls for a 4 ft. Impact Mat at entry and exit points—center either a 4x4, 4x6 or 4x8 mat at each opening

- The attendant should point out and make customers aware of the posted warning sign on the front or side of the inflatable
- **Attendants should watch for any signs of deflation such as sagging, wrinkling or distortion**—if observed, the attendant should ask the people in the inflatable to evacuate, calmly and safely
- Attendants should keep all spectators outside the inflatable amusement device and at least 5 feet away from the sides
- Starting line is 48 inches from the entry of the inflatable amusement device
- Prohibit excessive rough play by occupants—*blow whistle*
- In times of excessive heat monitor the heat inside play area and slide surface

OPERATING INSTRUCTIONS - cont.

Monitor the weather throughout the day, check for high wind (**15mph or higher**), rain, snow and lightning—do not use device in these conditions



15 mph!

The inflatable should not be operated if the wind exceeds 15 mph, or at temperatures of less than 40° F

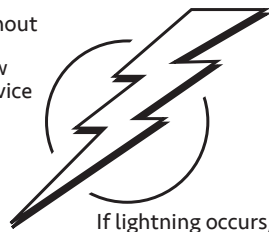

If lightning occurs, evacuate the unit immediately—unplug power

- Do not allow any individual in the rear of the game or near the electric blower at any time
- Deny entry if any patron poses a risk to others— or, if they consumed alcohol or illicit drugs
- **15mph** wind equals; dust and loose paper rising and movement of small branches —Hazardous winds; small trees sway and large branches are in motion
- **Check the blower, inflation tube and zipper flaps regularly, to ensure there isn't any unwanted air loss**
- Check stakes regularly
- Keep airborne trash/leaves clear of blower intake

DEFLATION AND FOLDING

Before deflation, remove all accessories that may be applicable to your unit—also be sure to use a quality broom and sweep the surface of the game free of any debris

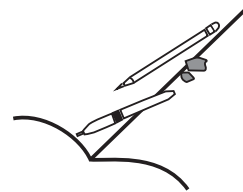

Check to make sure that no sharp objects have fallen into the seams of the game, Eg. pens, pencils, etc. —items such as these can cause damage to the inflatable during the rolling up process

- **Before deflating;** Inspect for any damage and repair as necessary
- **Clean** inflatable amusement device(s) and **dry**, after use—by running air through it
- Unplug blower at the power source
- Loosen first inflation/deflation tube strap and remove tube from blower cone —make sure tube is pulled away from the inflatable and is straight
- Loosen second inflation/deflation tube strap and pull tube away from inflatable
- Open all deflation flaps
- While the inflatable amusement device is deflating, remove stakes, put blower fan away, and store extension cord(s)

DEFLATION AND FOLDING- cont.

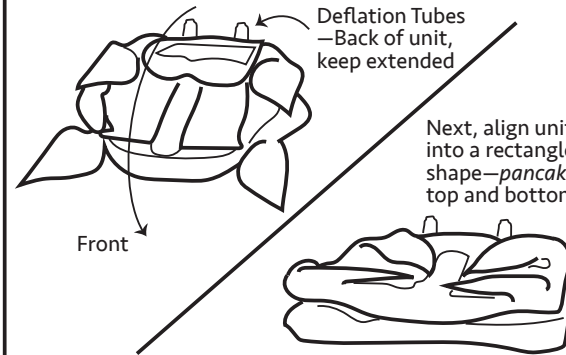

Deflation Tubes —Back of unit, keep extended

Next, align unit into a rectangle shape—*pancake* top and bottom

- Two people, minimum, needed to fold
- Guide inflatable inward and to the front —while the air is being released
- Begin folding inflatable amusement device—pull vertical peaks/shapes toward the front, to flatten and release more air
- Next, situate top of unit over the bottom, *pancake* style—and fold peaks into the middle, see (**drawing**)
- Once you make the folds, you will notice that air is still inside the game—start at the front and walk, in stocking feet, to the back—removing most of the air
- Work the air out towards the back of the unit through the inflation tube(s)
- Commercial inflatables take 5-15 minutes to completely deflate

CLEANING THE INFLATABLE



- Do not use M.E.K. (methyl ethyl ketone) to try and clean your inflatable, as this will damage the vinyl
- Do not use a chlorine based cleaner or bleach, as this may damage the threads
- Do not use any cleaning products containing alcohol to try and clean your inflatable device, as this will damage any printing that may be on your inflatable
- Use water and/or mild cleaner sparingly by *sponging*
- Excessive water or cleaner may penetrate the seams and collect inside of the tubes —also, *bubbling* from the seams during operation may occur

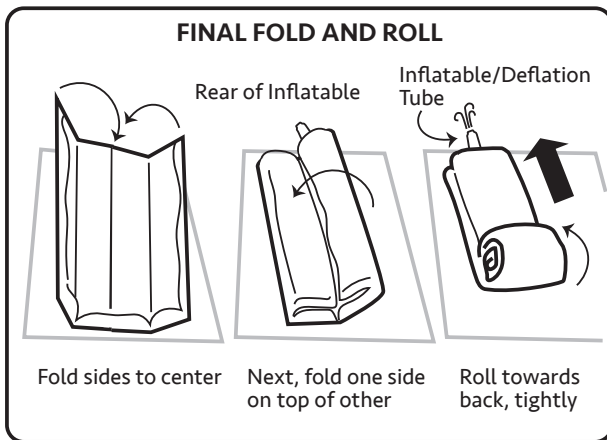

- Fold both sides into the center of the inflatable—each person should place one foot on the inflatable at the fold line
 - Fold at the same time—walk down the game and straighten out the seam
 - Repeat this procedure for the other half of the game
 - **The roll;** make sure that at least one of the inflation tubes is extending—as you roll the unit up, air will escape and the inflatable device will roll much better
- Important:** Twist the beginning of the 'roll' very tight
- Start your roll from the FRONT (opposite the inflation tube)
 - As you progress, be sure that the roll is straight and tight

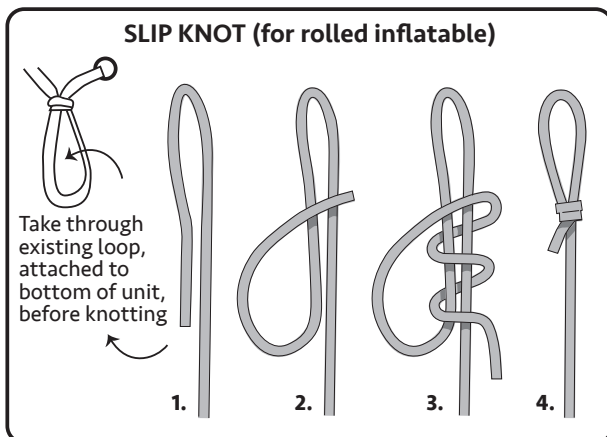

- Near the end, allow time for the last bit of air to escape
- Locate tie strap—pull to top of roll
- We recommend you tie a tight slip knot around the roll
- Stand the inflatable amusement device on end—place the transport/storage bag over one end of the game and work it down as far as you can

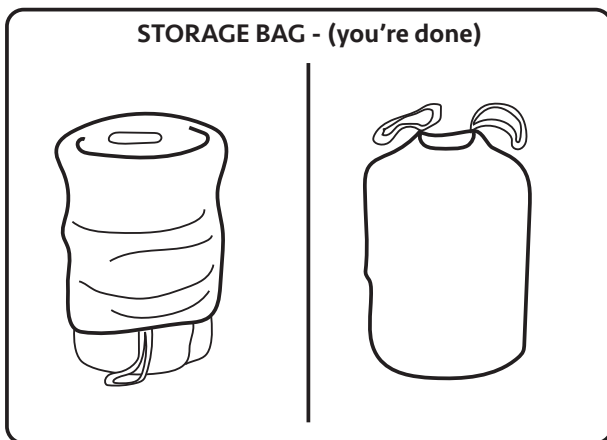

- It is important that you work the bag down to the top of the roll—flip the unit and pull the bag up over the top of the inflatable amusement device
 - Tie the bag closed
 - Lay the game onto a dolly and roll it to your designated storage area
- WARNING:** Inflatables are very heavy. Do not attempt to roll or move these games by yourself. When lifting any type of heavy weight, be sure to lift with your legs and not your back. If in doubt about your ability to move something, get help.

DIRECTIONS FOR USE:

(operator/attendants should be assisting patrons as they enter and exit the inflatable amusement device)

- Communicate to all patrons— safety, using the inflatable amusement device, usage and dress code rules
- Carefully enter inflatable amusement device at the entrance and climb the incline slowly
- Careful not to collide into other patrons, be respectful of others safety at all times
- When patrons are ready to slide, do so in a seated position, one at a time, with proper form (patrons may exit carefully out the entrance tunnel, if they do not wish to slide)
- Exit the device, after sliding, as careful as possible—no jumping off the edge of the device
- As one patron exits, allow another to enter— remember to maintain the correct device capacity (total number of patrons allowed, at one time)

EVACUATION PLAN:

In the case of rapid deflation or poor weather during operation, attendants should follow these steps—

- Operator/attendants should blow whistles to evacuate patrons immediately and safely— aid child patrons as they exit, then tell them to step away from inflatable device
- Any patrons on elevated platforms should climb down the stairs, backwards—if a patron is sitting ready to slide, let that one slide down, only (for units with slides)
- Deflate inflatable amusement device if necessary (high wind)— re-inflate when safe
- Call medical responders if anyone is injured



DAILY CHECK LIST:

- Check wind conditions at beginning of day and throughout the day.
- Ensure temperatures are greater than 40°F.
- Recheck the minimum 12 gauge- 3 wire extension cord and the CFCI (ground fault circuit interrupter).
- Ensure there are no obstructions in the blower.
- Ensure unit is properly inflated.
- Ensure all tether points are secure.
- Ensure all deflation zippers and flaps are closed.
- Walk around the unit and inspect seams and search for wear damage.

DEVICE NAME: Radical Run 1, Obstacle Course (SAMPLE SPECIFICATION PAGE)	
DIMENSIONS: 29' x 18' x 13'	DEVICE CAPACITY: (2) Patrons
INFLATION/DEFLATION TUBES: (2)	DEFLATION FLAPS: (4)
ANCHORS / TIE DOWNS: (9) / (0)	MINIMUM HEIGHT / MAXIMUM HEIGHT: 34 in. / 60 in. (check unit label!)
BLOWER: (1) - 1.5 HP	MAXIMUM WEIGHT: 180 lbs. per patron (check unit label!)
MINIMUM NUMBER OF TRAINED ATTENDANTS: (2)	SKU: DY-OC-RRR

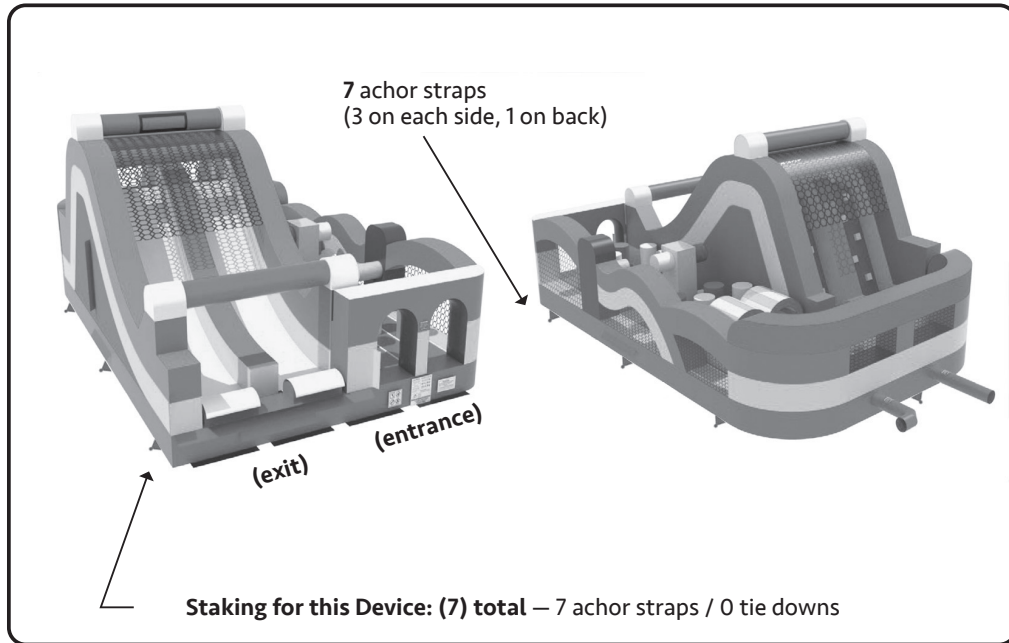

MAINTENANCE and INSPECTION

- Determine a cleaning and preventative maintenance schedule to keep this device function properly
- The device can be easily cleaned with a cloth or light brush. Use a vinyl cleaner and rinse lightly, to remove detergent before storing.
- **DO NOT PACK THE INFLATABLE DEVICE WHEN WET.** If it wasn't dried properly, lay the unit out to dry at the earliest opportunity.
- The unit should be inspected regularly for damage. If there is evidence of tearing at the anchor points or vinyl panels, the inflatable amusement device should not be used until the repair has been completed.

REPAIRS

- Repairs made by anyone other than the original manufacturer, shall be made using the same construction method—with comparable materials—unless manufacturer agrees otherwise.
- To repair small tears up to 12" use "Single Patch Method" as follows.
- Cut an oval or round vinyl patch approximately 4" larger than the cut.
- Clean the area around the tear.
- Apply SX-69 vinyl glue on the patch and on the surface of the inflatable device.
- Allow the manufacture's recommended drying time before applying the patch to the inflatable device as indicated on the label on the container.
- Place the patch covering the cut area and apply pressure for 1 minute. Refer to the glue manufacturer's label for the recommended time for glue to dry once the patch is applied.
- If the "Single Patch Method" is not a viable option use PatchALL* for a non-glue repair until you can apply the "Single Patch Method" or send the unit to a repair facility.

DAILY CHECKLIST

- Ensure maximum winds are less than the manufacturer's recommended wind speed requirement for unit.
- Ensure temperatures are greater than 40° F.
- Ensure that a minimum 12 gauge 3 wire extension cord is used with the blower and is connected to a GFCI (Ground Fault Circuit Interrupter).
- Ensure there are no obstructions in the blower(s), blower intake and the unit's inflation tubes.
- Inspect the blower inflation tubes, they should be in good condition and firmly fixed to blower.
- Ensure unit is properly inflated—with the blower pointing straight at device.
- Visually inspect device for any holes or rips in the fabric or seams.
- For inflatable amusement devices with multiple units, check all connection points.
- Ensure all tether and anchor points are secure. Check stakes.
- Ensure all deflation zippers and flaps are closed.
- Walk around the unit and inspect seams and search for wear damage.

* PatchALL are clear polyurethane patches or tape. They are quick, flexible, long lasting, airtight and waterproof—with no gluing. Visit TentAndTable.com for all your Inflatable Accessories including; blowers, impact mats, dollies, heavy-duty hand trucks and repair kits.

MODIFICATIONS: This inflatable amusement device shall not be altered in any way that constitutes a major modification without written from the device manufacturer.

*ASTM Int'l recommends 1" x 26" stakes for all commercial inflatable amusement devices, as a guideline. ASTM Int'l supports that this would be greater pullout capacity in windy condition (still below 15 mph) or, in the case of medium consistency soil conditions.

WARNING:

As with any Amusement Device, there is an inherent risk of personal injury. As such, ALL PERSONS play at their OWN RISK and peril!

If unit begins to deflate EXIT immediately!

DO NOT Operate this unit if WINDS exceed 15 M.P.H.

DO NOT Inflate or use this inflatable without first SECURING to ground. Use stakes at all tethering and anchor points.

DO NOT Pound stakes into ground without first VERIFYING gas, water & electrical locations with local UTILITY COMPANIES!

DO NOT Use silly string on unit.

SHOCK HAZARD!

DO NOT Use this equipment on DAMP surfaces or during inclement weather.

THIS UNIT REQUIRES A CONSTANT SOURCE OF 110V-20amp POWER PER BLOWER SYSTEM.

SAFETY RULES

ADULT SUPERVISION REQUIRED AT ALL TIMES!

 NO SHOES	 NO SHARP OBJECTS	 NO GLASSES	 NO JEWELRY	 NO FOOD OR DRINKS
 NO UNEVENLY MATCHED PLAYERS	 NO ROUGH PLAY	 NO TUMBLING OR FLIPPING	 NO PERSONS W/ MEDICAL CONDITIONS	 NO PREGNANT INDIVIDUALS
 MAXIMUM NUMBER OF PLAYERS	 MINIMUM HEIGHT	 MAXIMUM HEIGHT	 MAXIMUM WEIGHT PER PLAYER	 HEADGEAR REQUIRED

YES
 NO

Compliance Statement:

The vinyl and netting material used in the construction of this product is of the highest quality, 100% lead-free, adheres to MFR methods and was built to ASTM F2374 standards.



Name: _____
 Serial Number: _____
 Stakes Required: _____
 Blower Required: _____
 Made in China

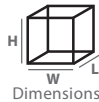

Inflated: _____
 L / W / H



DO NOT ENTER RIDE – UNLESS ATTENDANTS ARE PRESENT!

A MINIMUM OF _____ TRAINED OPERATOR(S) MUST BE ON DUTY AT ALL TIMES!

AIR LEAKING

OR BUBBLES FROM SEWN SEAMS ARE NORMAL DURING OPERATION OF THIS INFLATABLE

BLOWER MUST BE OPERATED CONTINUOUSLY DURING USE/PLAY!

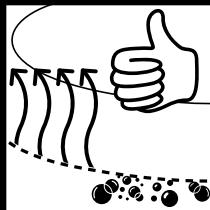

CHECK ALL SPECIFICATIONS LOCATED ON SAFETY LABEL- ATTACHED TO YOUR UNIT