









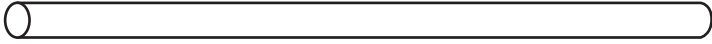
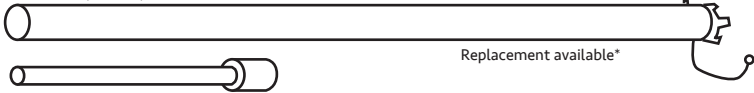

Assembly Instructions

**HIGH PEAK
FRAME TENT**

40' Hex

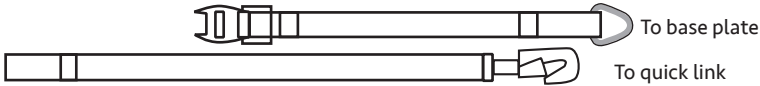
STEP 1. CHECK ITEM LIST

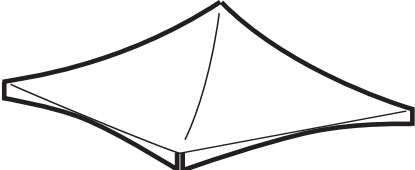
Item	Illustration (all parts available for replacement)	Tent Size	Quantity
Eave Spreader Bars	 <p>9'-3" (40hex)</p> <p>Replacement available*</p>	40' Hex	12
Center Mast Pole and Center Mast Pin	 <p>174" (40hex)</p> <p>Replacement available*</p> <p>SKU: BT-HPF-MAST-PEAKPIN SKU: BT-HPF-PEAKPLUG SKU: BT-FHCM174</p>	40' Hex	1
Leg Poles	 <p>9'-3" (40hex)</p> <p>Replacement available*</p>	40' Hex	6
Corner Fittings	 <p>SKU: BT-HEX-CORNER</p>	Hexagon	6
Side Tee Fittings		40' Hex	-
Connector	 <p>SKU: BT-HPF-INSERT-LG</p>	40' Hex	6
Cross Cables	 <p>Replacement available*</p>	40' Hex	3
Base Plates	 <p>SKU: BT-HPF-PLATE</p>		One per leg pole
1" Ratchet Strap Assembly w/ D-ring	 <p>To stake</p> <p>To outcrop-ring</p>		One per leg pole
2" Ratchet Strap Assembly (for base plate)	 <p>To base plate</p> <p>To quick link</p>		One per leg pole
Ratchet Rope (smaller tents only)			-
Base Stake	 <p>SKU: BT-SH-24-34STK</p>		One per leg pole
Ground Stake	 <p>SKU: BT-SH-24-34STK</p>		One per leg pole
Cross Bar (unique)			
Canopy Top		All sizes (see appendix A for more info)	1

*-Replacement available
-See website for size/sku

STEP 2. SAFETY CHECK LIST



- When building or assembling anything above shoulder height, wear a hard hat
- Steel toe boots are recommended
- Inspect the site, look for overhead and underground obstructions— such as utilities
- Call your local utility to have utility lines marked (call 3–5 days ahead)— **call811.com** is a good resource— ‘click’ 811 in Your State
- Inspect all ropes and tie lines
- Inspect poles, making sure there are no bends or breaks
- Replace or repair any items in poor condition

STEP 3. CONNECT BARS

Position tarp in the exact position desired
(use small objects as weights on a windy day)

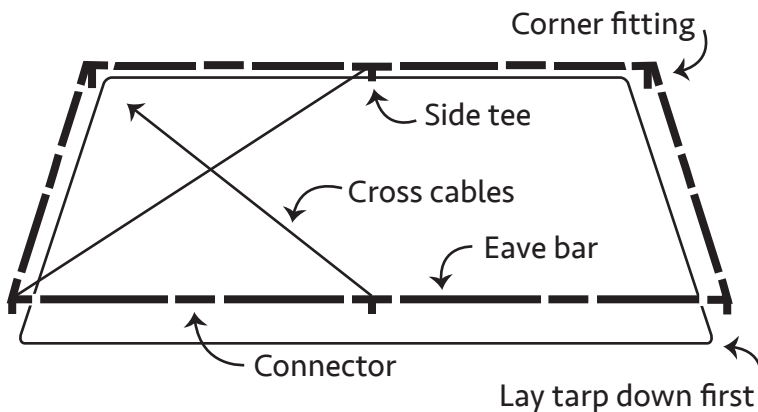

- Spread tarps (sold separately) in the tent location, to protect canopy— tarp should be as large as canopy
- Place eave bars, corner fittings, side fittings and connectors on tarp
- Connect all fittings
- See (**appendix A**) for your specific size and layout
- Insert corner bars (30x30 tent only)
- Next, connect cross cables— corner to corner— see (**appendix A**)
- The last cable is attached differently see (**figure A**)
- Note: Cross cables should be above any corner bracing

FIGURE A. LAST CABLE

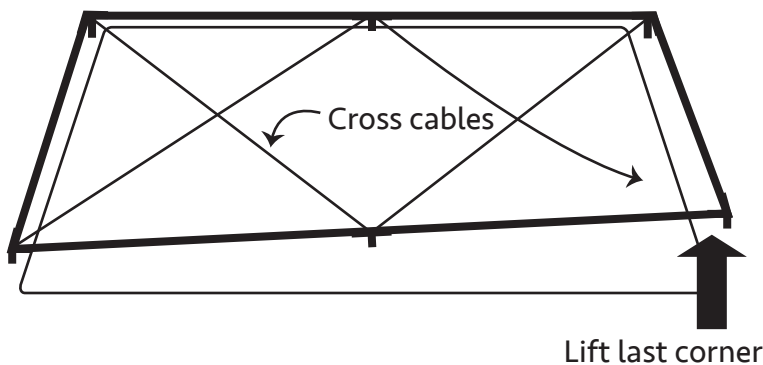

- Because of the tension build-up the last cable is connected easier in this manner
- Lift the last corner, 4 feet or higher to connect the last cable end to the corner hook— Lifting corner actually reduces the distance between the two corners
- See (**appendix A**) for your specific size and cable layout

STEP 4. CANOPY TOP

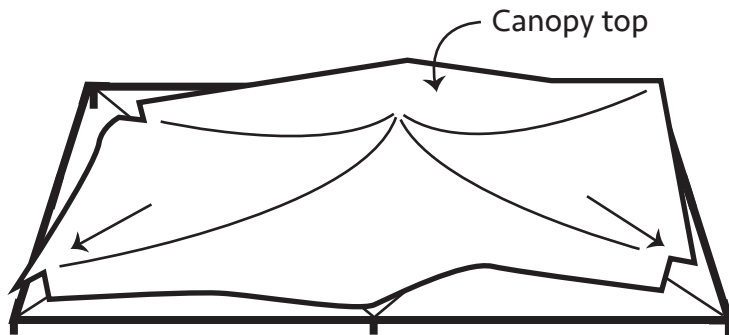

- Unfold canopy top over cross cables and tarp
- DO NOT walk on canopy
- Center the top and stretch to edges (flap as you go, to create 'lift')

Note: Locate the O-ring pull strap attached to one of the corner loops, that should be the last loop to be put in place—the strap can be used to pull the loop in place

- Connect three corners first, to the corner fittings
- See **(figure B.)**
- The last corner requires the use of an anchoring stake

FIGURE B. - CORNER LOOP

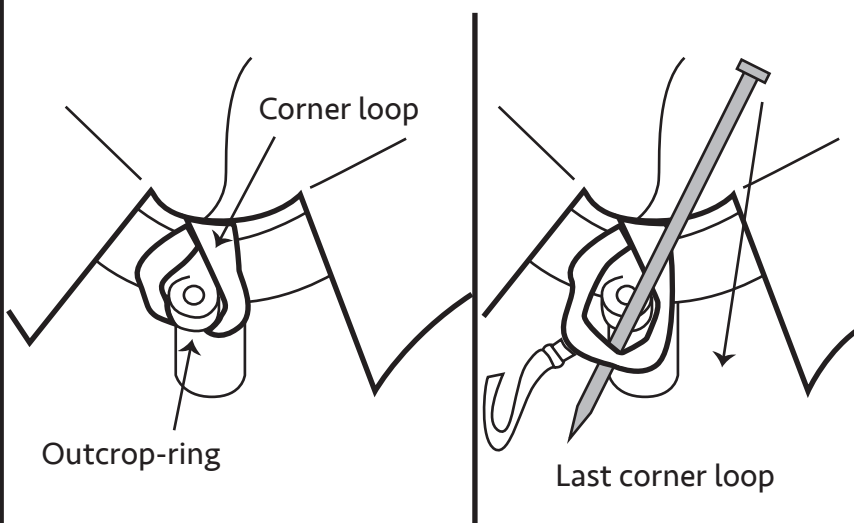

- Pull the first three corner loops over the corresponding outcrop-ring
- For the last loop, place an anchoring stake through loop and against outcrop
- Pull corner loop and pry at the same time— (pull stake back, away from tent)
- Finally, push loop in place and slide out anchoring stake
- Use O-ring pull strap to pull the loop into place

STEP 5. POSITIONING STAKES

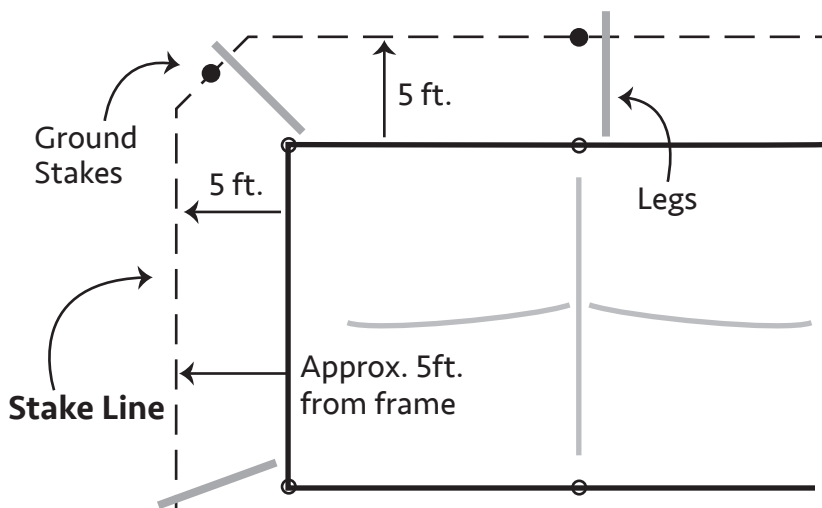

- With the canopy on and the frame in place, measure for ground stake location
- Lay leg poles around frame to help guide your measurement
- Measure 5 feet straight out from frame, at each leg connector
- Slide stake through D-ring of 1" ratchet strap, before you continue
- Remember, one ground stake per leg pole at the stake line, see **(figure C)** for proper staking

STEP 6. ATTACHING 1" STRAPS

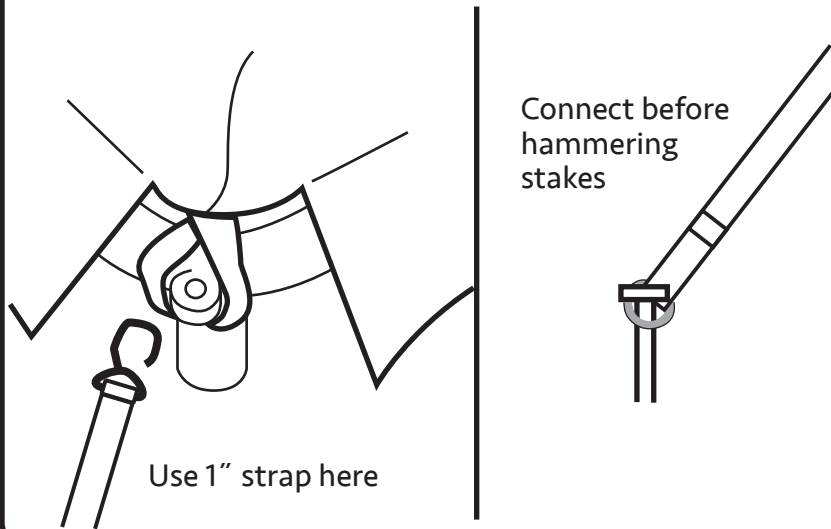

- At this time, slide stakes through all of the D-rings, that are connected to the 1" straps
- Hammer all stakes in position (half-way)
- Attach the *hook end* of the 1" ratchet strap assembly to all outcrop rings
- Connect straps together, using ratchet

See (page 6) for Ratchet Strap use

- This makes complete 1" ratchet strap assemblies, both ends connected—leave some slack, for now

FIGURE C. HAMMERING STAKES

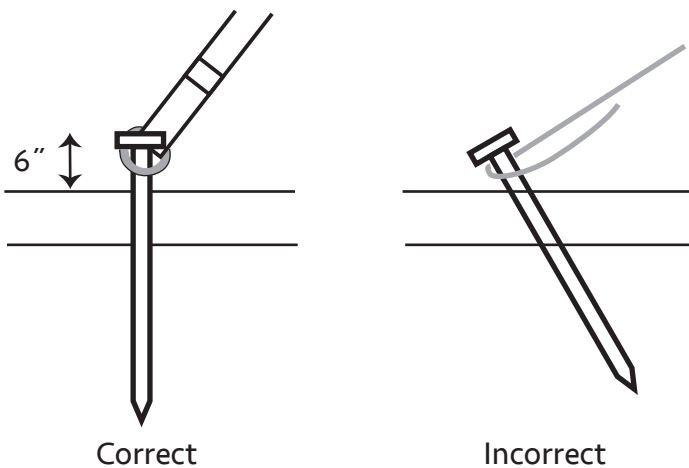

- Ground stakes should be hammered in vertical, not angled (sledge hammer required)
- Determine the longest side of your tent—this is where the first two leg poles will be installed—
Check connection of 1" ratchet strap, from frame to ground stake, before these two legs are installed
- Complete the hammering process, before you install each leg—leave 6 inches showing, above the ground

STEP 7. INSERTING LEG POLES

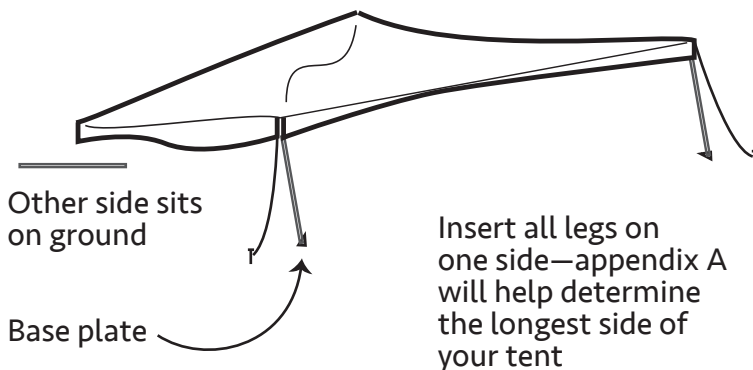

- Lift first corner of frame
 - Insert legs on one side (remember pick the longest side, for rectangle tents)
 - Slide base plate onto these legs—anchor hole should be facing interior of tent
 - 1" Ratchet straps should have some slack in them, at this point
 - The center pole goes in, before the leg poles on the other side
- Note: Large tents require *frame tent jacks*—general rules are, one jack every 20' and never place jack in the middle of bar (set-up and use can be found on internet)

Note: For the HEXAGON tent, install three consecutive legs as side one—the rest of the assembly is the same

STEP 8. BASE PLATE STRAPS

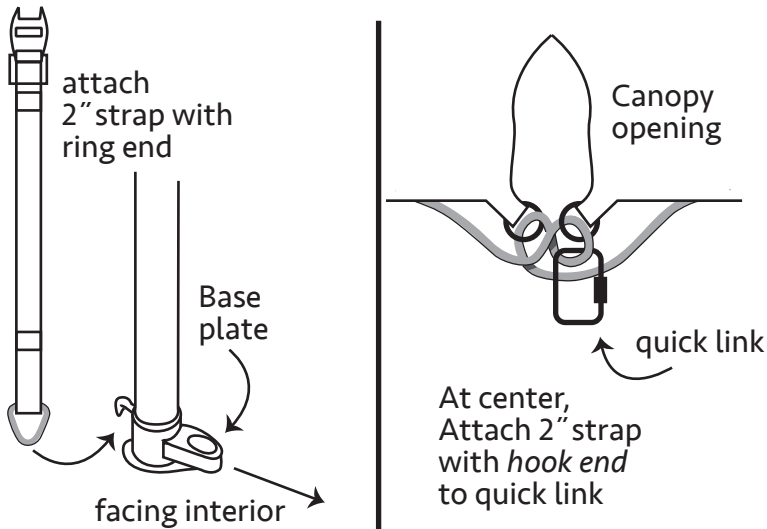

- For every leg pole, there is a base plate and a 2" ratchet strap assembly—connect the straps as the legs are installed
 - Connect *hook end* to quick link and *ring end* to base plate hook
 - Tighten strap
- See (page 6) for Ratchet Strap use

Note: Ratchet ropes are provided for smaller tents—for connection to base plate

- Clip ratchet rope to quick link—Loop rope around base hook and back up to linking unit

STEP 9. POSITIONING CENTER POLE

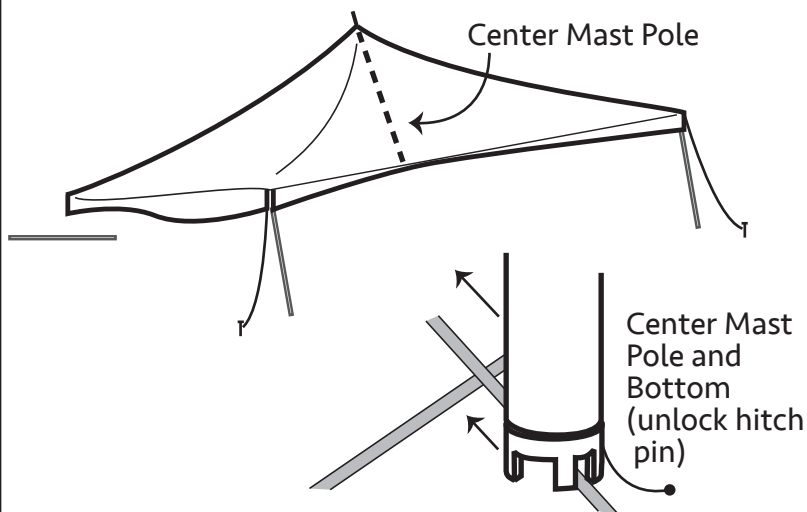

- One side of canopy still remains on tarp
- Lift center mast (two people will get this step done quicker)—walk under canopy, keeping the pole angled
- Insert mast pin into grommet at center of canopy (make sure entire pin is through and visible from outside)
- With the pole at an angle (not vertical), lay notched bottom on the outer end of the top cable—then slide the pole towards the center
- Make sure mast pin stays in place
- At center, where cables cross, position notched bottom over all the cables
- Lock hitch pin around cables to the other side of pole

STEP 10. INSTALL REMAINING LEGS

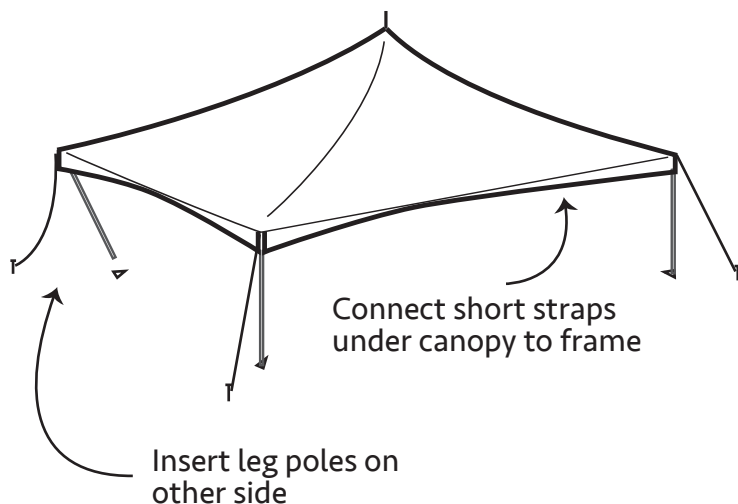

- Under canopy you will see several short straps—connect these to frame—not too tight
- Raise other side of tent (2 people required)—start at corner
- Insert leg poles—the leg poles should be vertical at this step
- Slide base plate onto these legs
- Next, secure canopy to remaining base plates, with corresponding 2" strap or ratchet rope
- **TIGHTEN ALL 1" RATCHET STRAPS**
- Lastly, secure base plates to ground by hammering in the base stakes

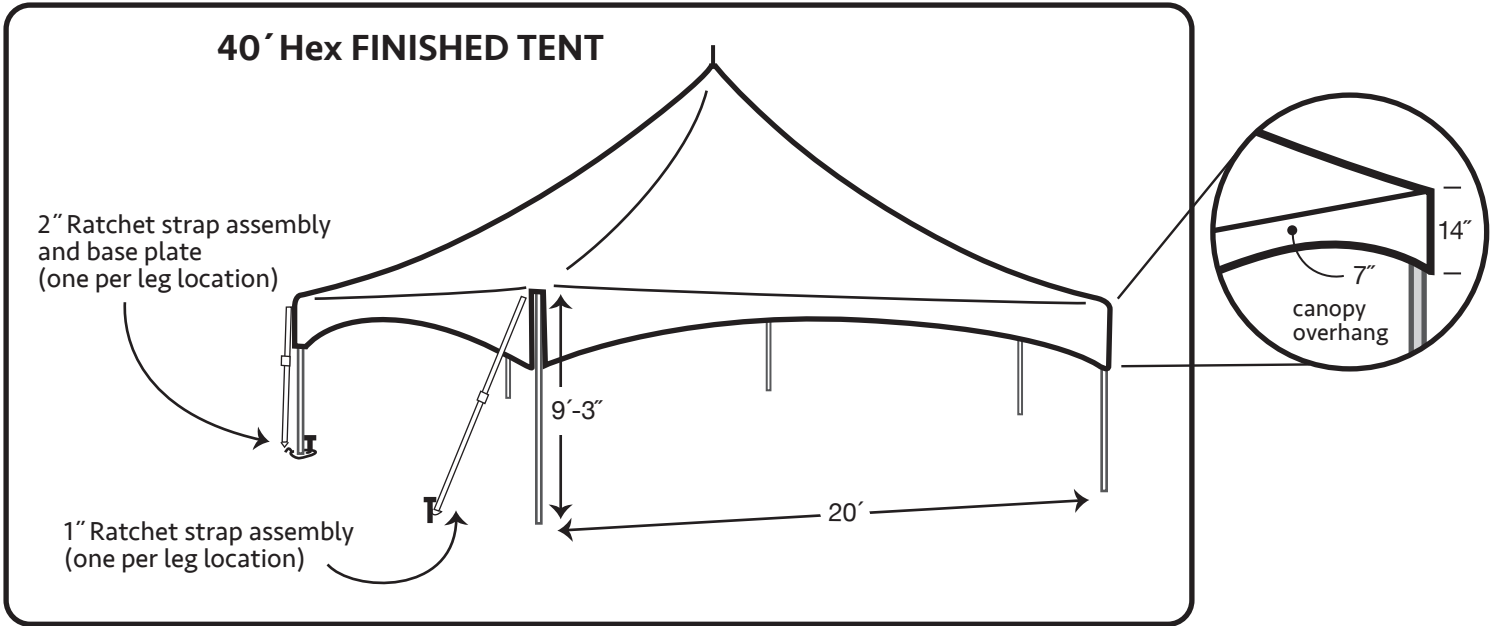

STRIKE PROCEDURE (basically, reverse order from assembly)

- 1.) Remove base stakes
- 2.) Detach short straps under canopy
- 3.) Remove straps on one side
- 4.) Remove leg poles, on one side
- 5.) Remove side leg poles, (adjacent side of 30 x 30 tent, only)
- 6.) Remove center mast
- 7.) Lay tarp under canopy
- 8.) Remove remaining straps
- 9.) Remove remaining legs (opposite, long side)
- 10.) Fold canopy
- 11.) Remove ground stakes

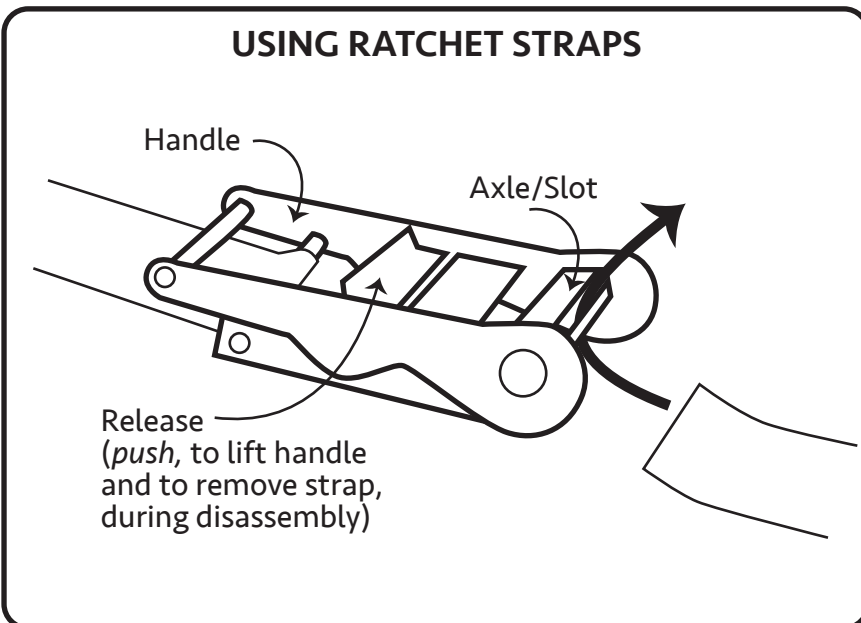

- Release handle, crank until slot is pointing up
- Close handle
- Pass strap underneath and through the slot (as shown)
- While holding the whole strap assembly attach both ends (eg. tent to stake)
- Remove slack, before tightening
- Push 'release'— lift handle and tighten ratchet
- Roll-up any excess strap, put under handle
- Close handle

APPENDIX -A

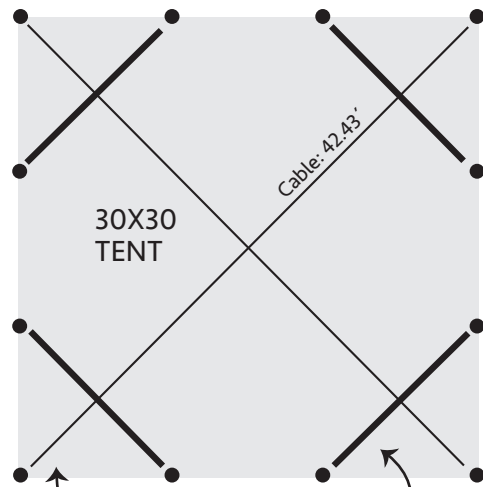
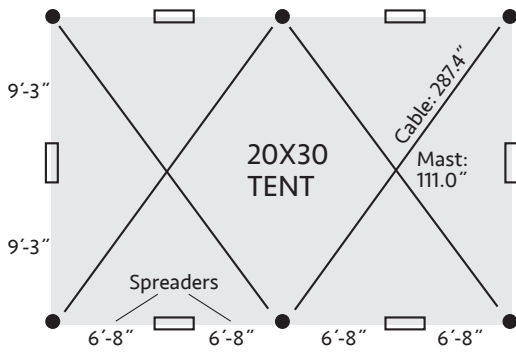
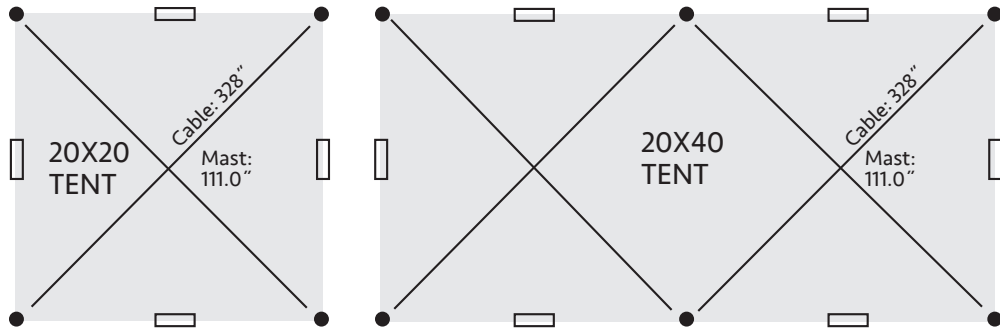
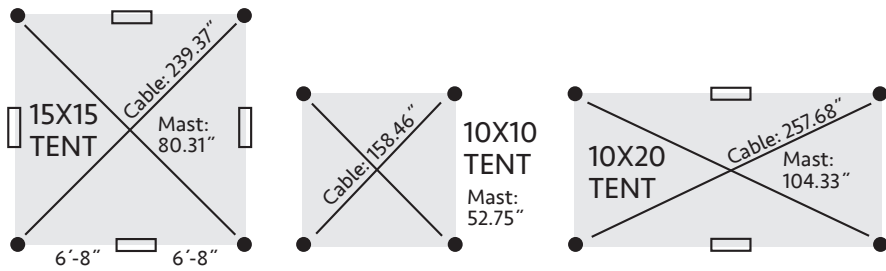

Corner Bars—30 x 30 only
(cables go above bars)

Cable set-up

Leg pole positions

Connector positions

