



888 322-5606 (toll free)

Assembly Instructions

WEST COAST FRAME TENTS

10'x10' /	20'x20'
10'x20' /	20'x30'
15'x15' /	20'x40'
15'x30' /	20'x60'

WEST COAST TENT OVERVIEW

West Coast designed tents involved less frame work, with no center poles. This tent features stronger tubes, fewer parts which makes for faster set-up. It's worth pointing out fewer parts means; less load, less to assemble, faster set-up and faster strike time. For investment purposes, the frames are expandable. With the purchase of extra parts you can easily make a second, larger tent.

Take a look here at the basic design.

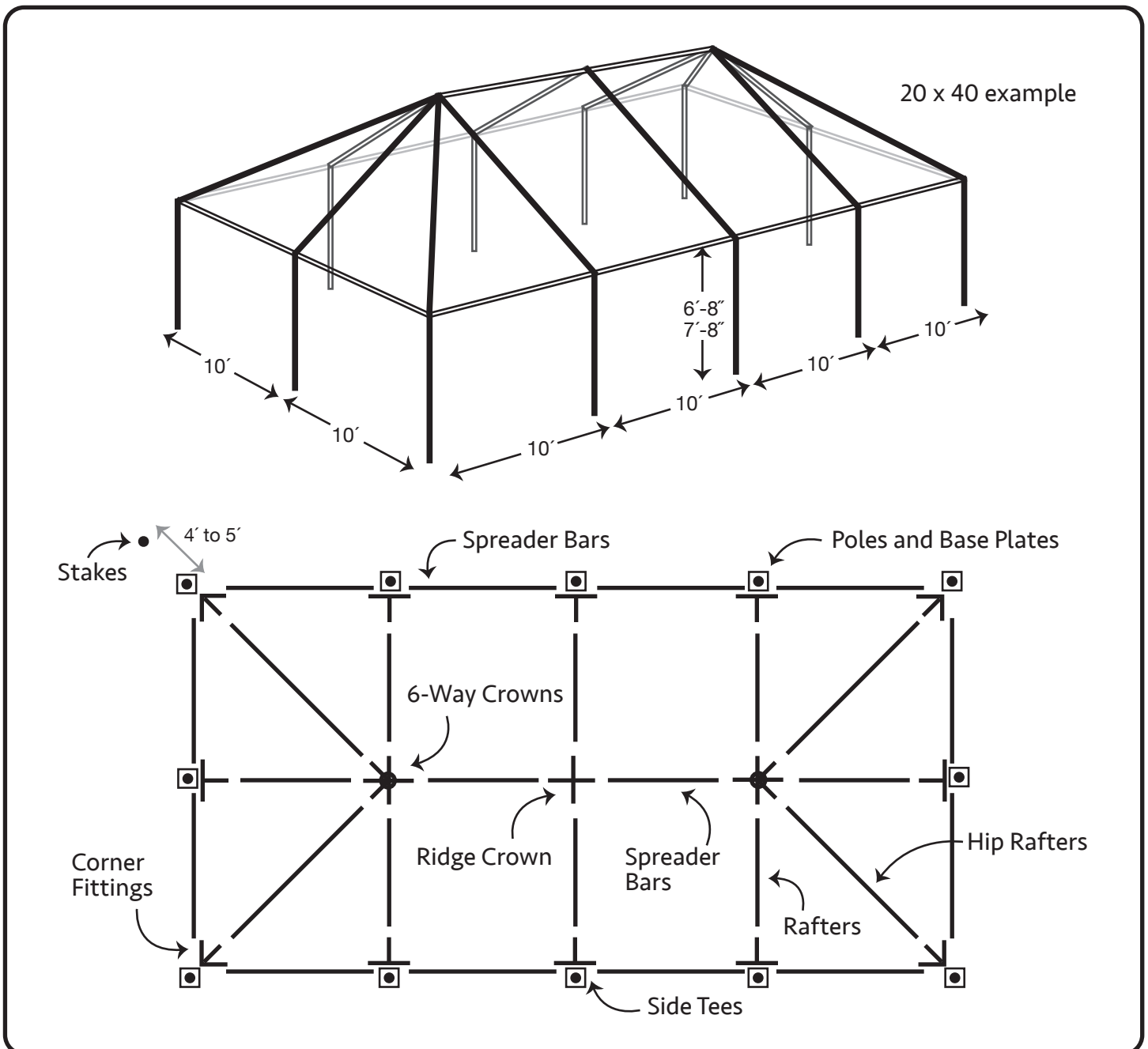

STEP 1. CHECK ITEM LIST (10ft. and 20ft. wide tents)

Item	Illustration (all parts available for replacement)	Size	Qty.	Size	Qty.	
Hip Rafters (yellow/red)	Size: A: 6'-10" (yellow) SKU: BT-WCF-PIPE-82 	10x10	4-A	15x30	4-A	
	Size: B: 14'-4" (red) SKU: BT-WCF-PIPE-RED 	10x20	4-A	20x20	4-B	
	Size: C: 21'-10" (red) SKU: BT-WCF-POLE21-10 	15x15	4-A	20x30	4-B	
Rafters (green/red)	Size: A: 4'-11" (green) SKU: BT-WCF-PIPE-82 	10x10	-	15x30	2-B	
	Size: B: 7'-8" (black) SKU: BT-WCF-POLE16-1 	10x20	2-A	20x20	4-C	
	Size: C: 10'-6" (green) SKU: BT-WCF-POLE21-10 	15x15	-	20x30	6-C	
Spreaders (white/red)	Size: A: 9'-4" (white) SKU: BT-WCF-PIPE-WHITE 	10x10	4-A	20x20	8-A	
	Size: B: 14'-4" (red) SKU: BT-WCF-PIPE-RED 	10x20	7-A	20x30	11-A	
		15x15	4-B	20x40	14-A	
Leg Poles / Base Plates (black)	Sizes: 6'-8" (brown) and 7'-8" (black) SKU: BT-WCF-LEG-7 	SKU: BT-WCF-PLATE	10x10	4	20x20	8
			10x20	6	20x30	10
			15x15	4	20x40	12
			15x30	6	20x60	16
Corner Fittings	SKU: WCF-CORNER	10x10	4	20x20	4	
		10x20	4	20x30	4	
		15x15	4	20x40	4	
		15x30	4	20x60	4	
Side Tee Fittings	SKU: BT-WCF-SIDET4	10x10	-	20x20	4	
		10x20	2	20x30	6	
		15x15	-	20x40	8	
		15x30	-	20x60	10	
6-Way Crowns	SKU: BT-WCF-CROWN6	10x10	-	20x20	-	
		10x20	-	20x30	2	
		15x15	-	20x40	2	
		15x30	-	20x60	2	
8-Way Crowns	SKU: BT-WCF-CROWN8	20x20	1			
Ridge Crowns	SKU: BT-WCF-CROWNR	10x10	-	20x20	-	
		10x20	-	20x30	-	
		15x15	-	20x40	1	
		15x30	-	20x60	3	
(Crowns)	4-WAY CROWN SKU: BT-WCF-CROWN4 20x20 (1)	3-WAY CROWN SKU: BT-WCF-CROWN3 10x20 (2) / 15x30 (2)	2-WAY ADJUST. CROWN SKU: BT-WCF-CROWN2 10x20 (1) / 15x30 (1)			
Rope- 12ft., w/ loop	SKU: BT-38ROPE-12L	10x10	4	20x20	8	
		10x20	6	20x30	10	
		15x15	4	20x40	12	
		15x30	6	20x60	16	
'R' Pins	SKU: BT-WCF-RPIN-50	10x10	24	20x20	48	
		10x20	38	20x30	62	
		15x15	24	20x40	76	
		15x30	38	20x60	104	
Single Head Stakes (3/4"x 30")	SKU: BT-SH-30-34STK-4	10x10	4	20x20	8	
		10x20	6	20x30	10	
		15x15	4	20x40	12	
		15x30	6	20x60	16	
Canopy Top		All sizes-			1	
		(see appendix for more info)				

STEP 1. CONTINUED

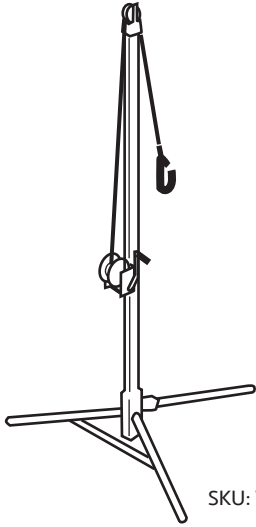

SKU: WCF-JACK-12

This item is very important in the process, Frame Tent Jack (sold separately). Some West Coast Frame tents require *frame tent jacks*—and larger tents require multiple jacks.

General rules are; work on the long side, one side at a time, and never place jack in the middle of a spreader bar. (set-up and use can be found on internet)

Tent Size	Estimated Quantity
10 x 10	none
10 x 20	none
15 x 15	none
15 x 30	2
20 x 20	none
20 x 30	2
20 x 40	3
20 x 60	4

Recommended Tools

6ft. step ladders
Sledge Hammer
Tape Measure

Stake Driver
(for larger tents)

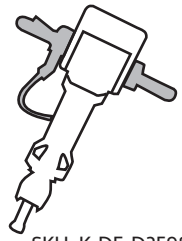

SKU: K-DE-D25980K

WARNING

Tent products are manufactured for use as temporary structure and do not meet structural code, unless specified. Since weather is unpredictable, the customer must incorporate their own good judgment, common sense & knowledge of local conditions with the installation instruction guidelines. The customer is responsible to anticipate weather severity for proper time and method of construction.

'BEFORE YOU DIG' (hammer stakes)

By Law you are required to contact your local "Call before you dig" number before you plan to dig. After calling, your local utility company will mark the location of underground utility lines. Laws from state to state vary on how far in advance you must call.

Planning ahead and checking with your state's program is always a smart idea. Failure to obtain a line location before digging can result in a substantial fine. Please find your local "call before your dig number" by going to call811.com.

STEP 2. SAFETY CHECK LIST



- When building or assembling anything above shoulder height, wear a hard hat
- Steel toe boots are recommended
- Inspect the site, look for overhead and underground obstructions— such as utilities
- Call your local utility to have utility lines marked (call 3–5 days ahead)— call811.com is a good resource— 'click' 811 in Your State
- Inspect all ropes and tie lines
- Inspect poles, making sure there are no bends or breaks
- Replace or repair any items in poor condition

STEP 3. LAYOUT FRAME

Position parts in the exact location of finished tent

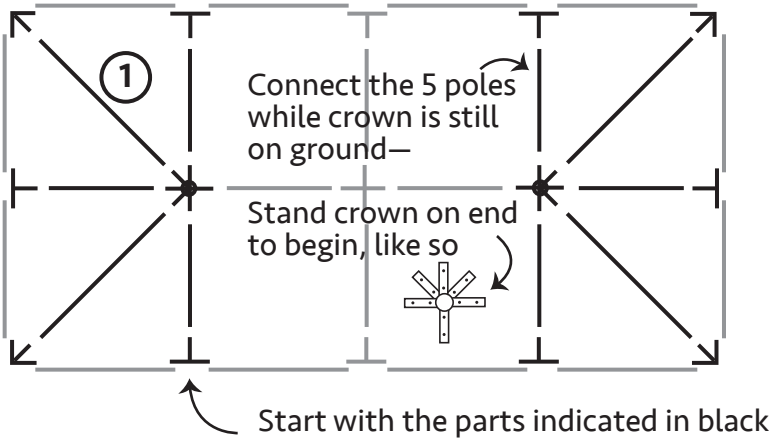

- Place all tent poles and fittings on the ground in the location you have selected for the finished tent
- This layout illustrates a 20 x 40 tent — see (**appendix A/B**) for your specific size, layout and pole sizes
- 1) Start with the crown and its connecting poles—the drawing shows the correct position of the crown—secure these parts using (2) 'R' pins per pole
- See (**figure A.**) for 'R' pin usage
- Stand these two end assemblies up, to connect the ridge parts next

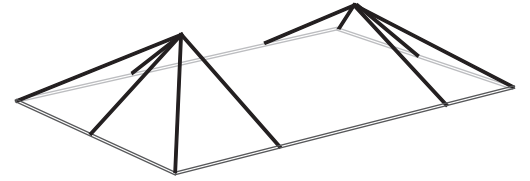
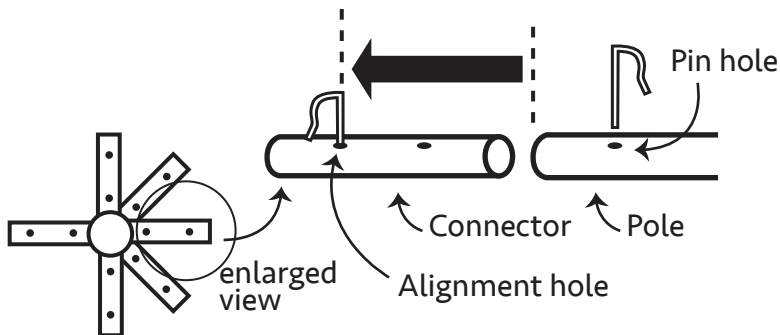

FIGURE A. 'R' PIN AND ALIGNMENT HOLE



- All connection will be made using this method—2 pins needed
- Insert a pin, halfway, into the alignment hole—this will act as *stop*, for spreader and rafter bars
- Slide pole (spreader, rafter etc.), onto the appropriate connector—touch the *alignment pin*, as a guide
- The pin holes are now lined up—insert the second 'R' pin, all the way, until it locks in place

Reminder:

Frame plans and connector positions, for your tent, appear in the appendix

STEP 4. RIDGE AND PERIMETER

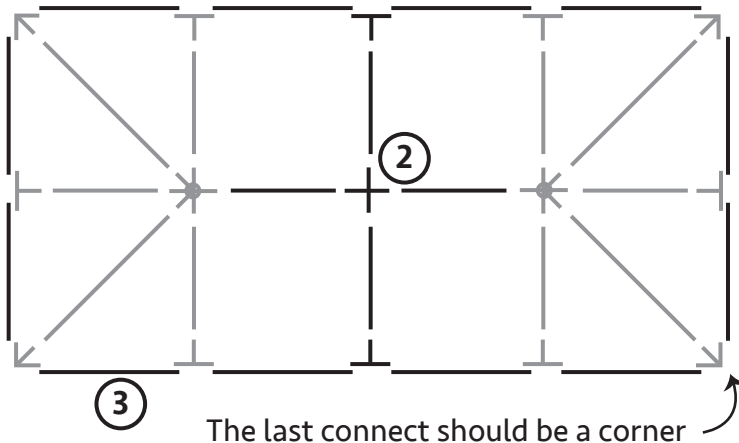

- 2) Connect the ridge line next, crowns and spreaders
- While standing on a ladder(s) make all connections from end to end
- If you are short of people, use a tent jack to hold horizontal poles
- 3) Lastly, connect all perimeter bars to the upper spreaders and rafter bars
- When working around the perimeter, the last connection should be at a corner, *not* a side tee
- The frame should now be complete

STEP 5. COMPLETED FRAME

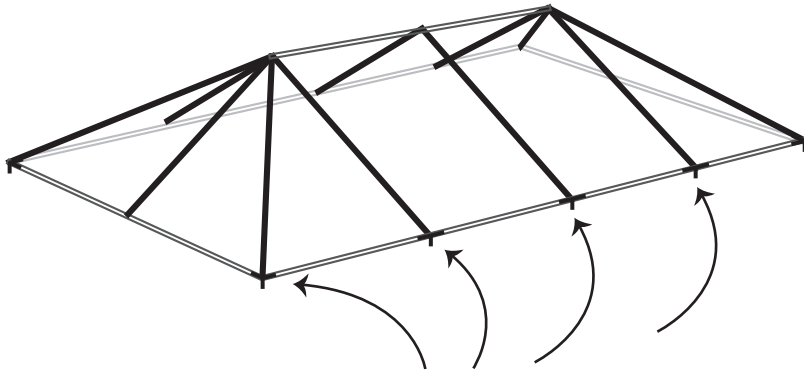

If repositioning is necessary, try to have one person lift at each fitting, all the way around

- Now that the frame portion is complete and while the frame is still on the ground, double check the 'R'-pins
- Also, with plenty of hands on deck, lift and adjust frame position if needed, at this point
- Always lift at a side or corner fitting

STEP 6. ANCHOR ROPES

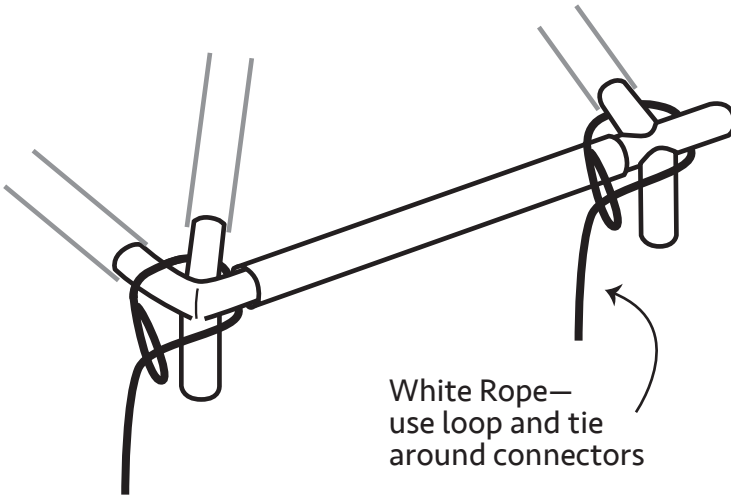

White Rope—
use loop and tie
around connectors

- While frame is still on the ground, tie anchor ropes to the frame
- The ropes will be secured to the tent stakes at the end of the assembly
- One rope per leg pole
- The ropes go under and over, to prevent them from sliding away from leg—see (**drawing**)

Note: this step can occur after the leg poles have been installed and the frame is elevated

STEP 7. CANOPY

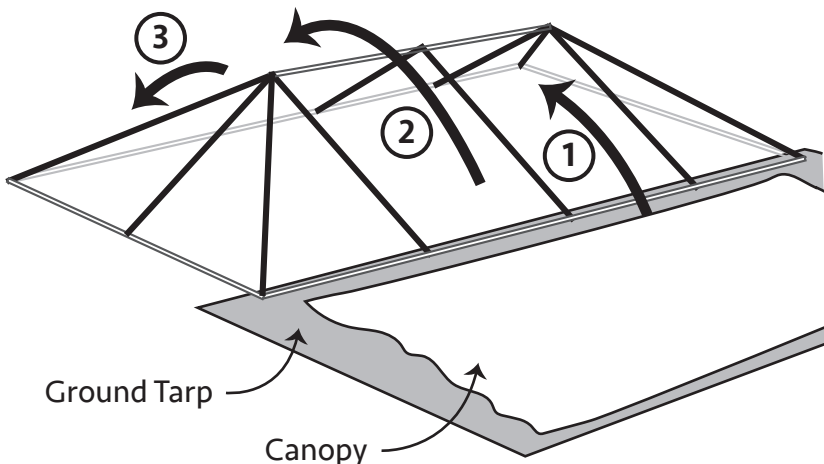

Ground Tarp

Canopy

- Once again, while frame is still on the ground, lay down a tarp(s), to protect canopy—arrange canopy along one of the long sides of the tent
- Place a ladder(s) next to ridge spreaders —as many as it takes to easily to pull canopy over ridge
- One person needed for every 10ft of tent
- 1) In unison, pull canopy up one side—'flapping' in the beginning, to create lift—then stop
- 2) Have most people stay on the ground, and a couple people on ladders—pull canopy over the ridge
- 3) Pull down the other side—'flapping' for all three steps

STEP 8. CANOPY CORNERS

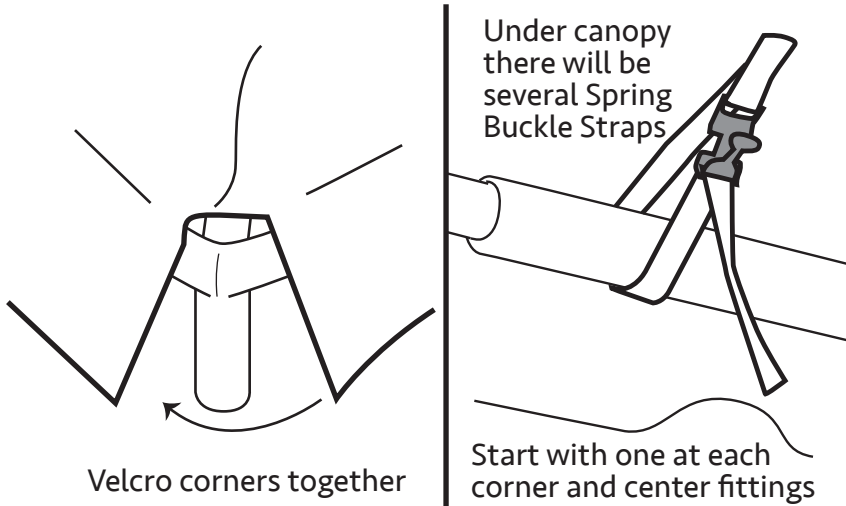

- After canopy is pulled over frame and corners are pulled into position, velcro corner seams together, loosely—tighten after legs are installed
- The canopy should be attached to the frame, before legs are connected—secure some of the spring buckle straps, to keep canopy in place—start near corners and center fittings
- Spring buckle straps are located on the underside of canopy
- Secure the remaining straps after legs are installed on one side and secure—it's easier at this height—Final tightening happens after legs are installed (**step 10**)

STEP 9. BASE PLATES

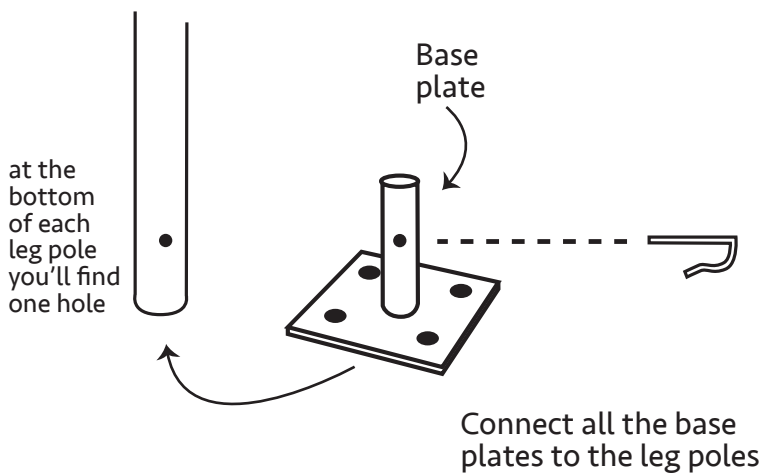

- Before the tent is raised, prepare the leg poles
- Place poles on top of base plate and secure with 'R' pins
- Do this for all the leg poles

STEP 10. INSTALLING LEGS (smaller tents)

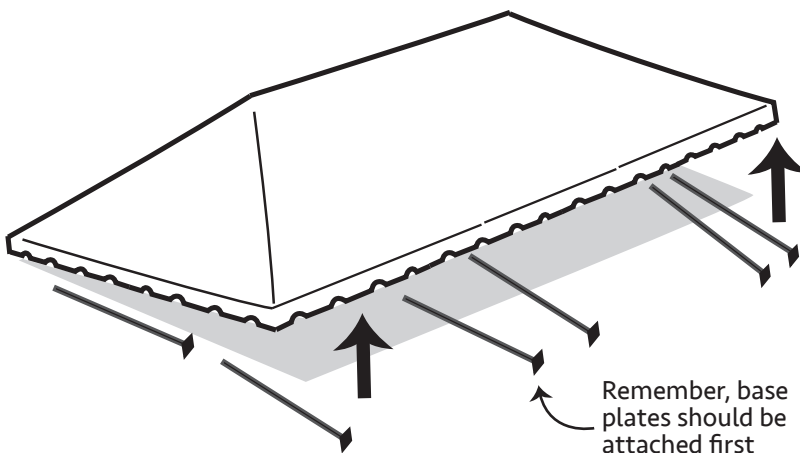

- For smaller tents, (10x10, 10x20, 15x15, 20x20) three or four people should be able to raise the frame and install the leg poles
- Locate one of the long sides of the frame—this will be raised first, while the opposite side remains on the ground
- **Important:** Lift the entire side of the frame at once (not one corner)
- Install all the legs on this side—secure with 'R' pins—
- Repeat for opposite side, then install legs for the remaining two sides
- *Double check the canopy corners—pull them down tight and straight*
- **Important:** tighten spring buckle straps—for security and to help pull canopy corners into place

STEP 10. INSTALLING LEGS (15x30 and larger tents)

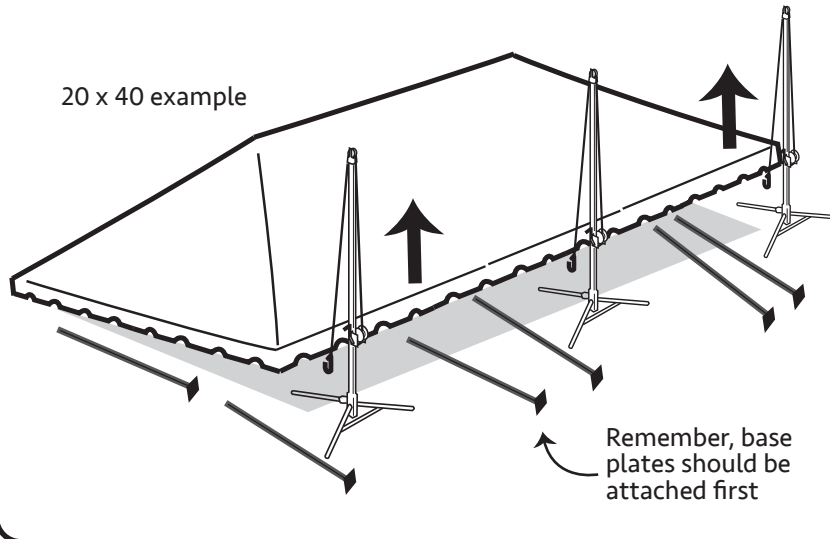

- For larger tents, (15x30 and larger) frame tent jacks should be used to raise the frame and install the leg poles
- Locate one of the long sides of the frame—this will be raised first, while the opposite side remains on the ground
- **Important:** Lift the entire side of the frame at once (not one corner)—crank jacks in unison
- General rules are; work on the long side, one side at a time, and never place jack in the middle of a spreader bar*
- Install all the legs on this side—secure with 'R' pins
- Repeat for opposite side, then install legs for the remaining two sides
- **Important:** tighten spring buckle straps—for security and to help pull canopy corners into place

STEP 11. STAKE LINE

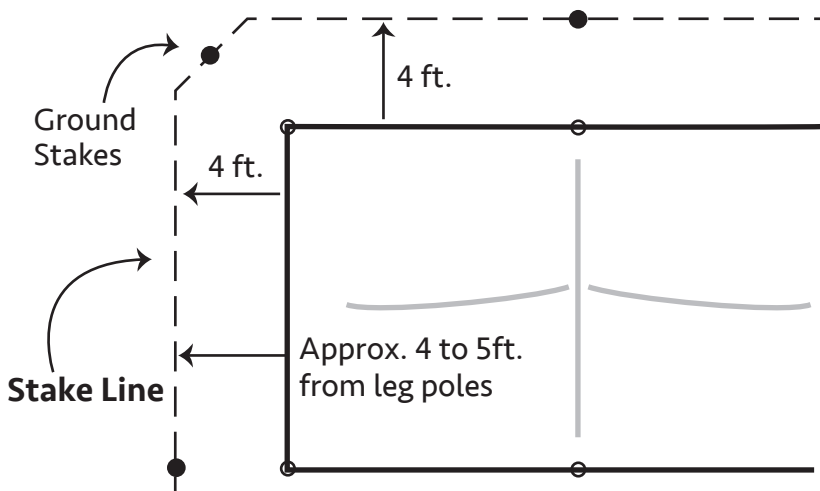

- **Double check leg poles**—making sure each pole is straight and lined up correctly, while tent jacks are still handy
- Once the tent is vertical and all the leg poles are attached, begin the process of staking the tent—with plenty of hands on deck, lift and adjust tent position if needed, first
- Measure 4 ft. out from each leg pole and place a stake in the ground
- Stakes should look uniform, around the tent—and 6 inches above ground see (figure B)
- Stakes should then be hand hammered or for larger installs, use a stake driver

FIGURE B. HAMMERING STAKES

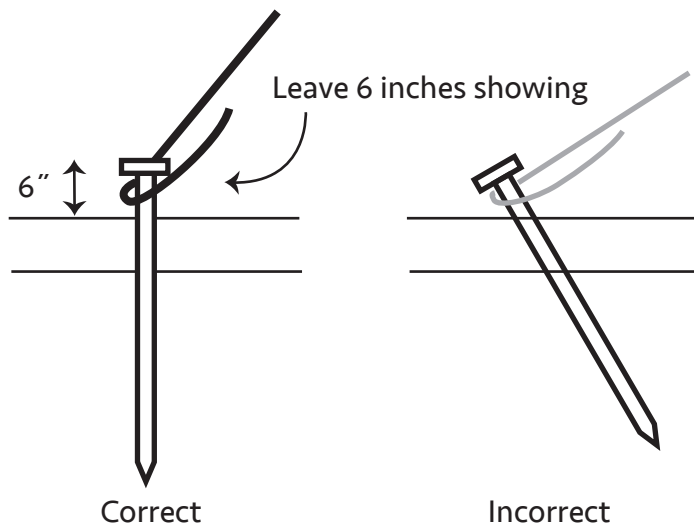

- Ground stakes should be hammered in vertical, not angled (sledge hammer required)
- Complete the hammering process by driving the stakes in and leaving 6 inches showing
- Connection of ropes to ground stakes, can be made with a few different secure knots (see figure C, page 8) for one of the more commonly used knots

STEP 12. SECURING ROPES

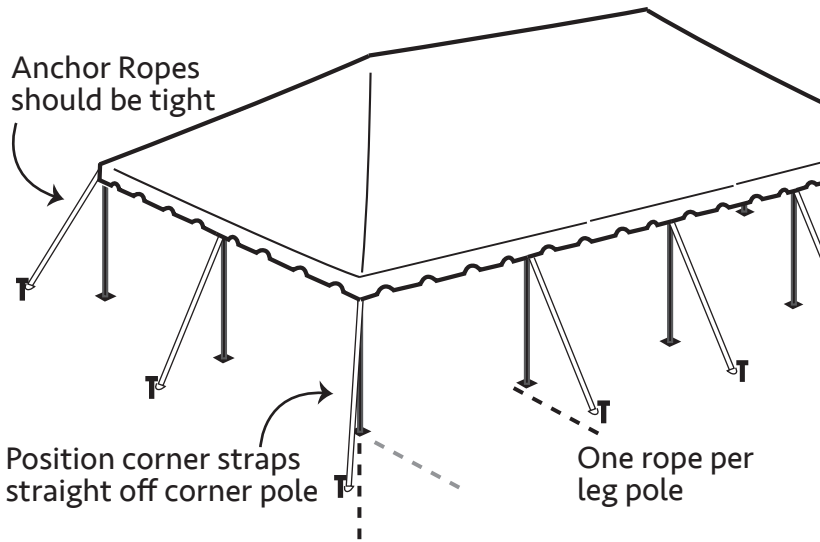

- As the assembly nears completion it is time to tighten all ropes/ratchet straps
- Keep an eye any lean that might be caused by the tightening process
- Go around the tent, make adjustments for any leg pole and tent lean
- Smaller tents use ropes to secure the tent to the stakes— see (figure C)
- Finally, secure any remaining spring buckle straps, under the canopy, that were not secured in step 8

FIGURE C. CLOVE-HITCH KNOT

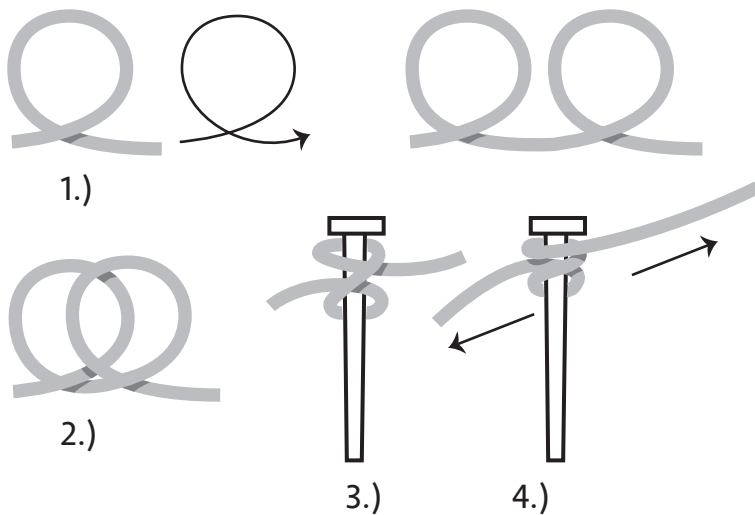

- A commonly used knot for securing a rope to stake is the *clove-hitch*
- 1.) Make two loops
- 2.) Cross loops by placing second loop over the first
- 3.) Place the combined loops over stake
Option: loops can be form directly on stake
- 4.) Pull on both ends to tighten rope
Note: outward force tightens and inward force loosens the knot—when making adjustments
- 5.) Excess line should be pulled half-way up the rope and tied off

FINISHED TENT

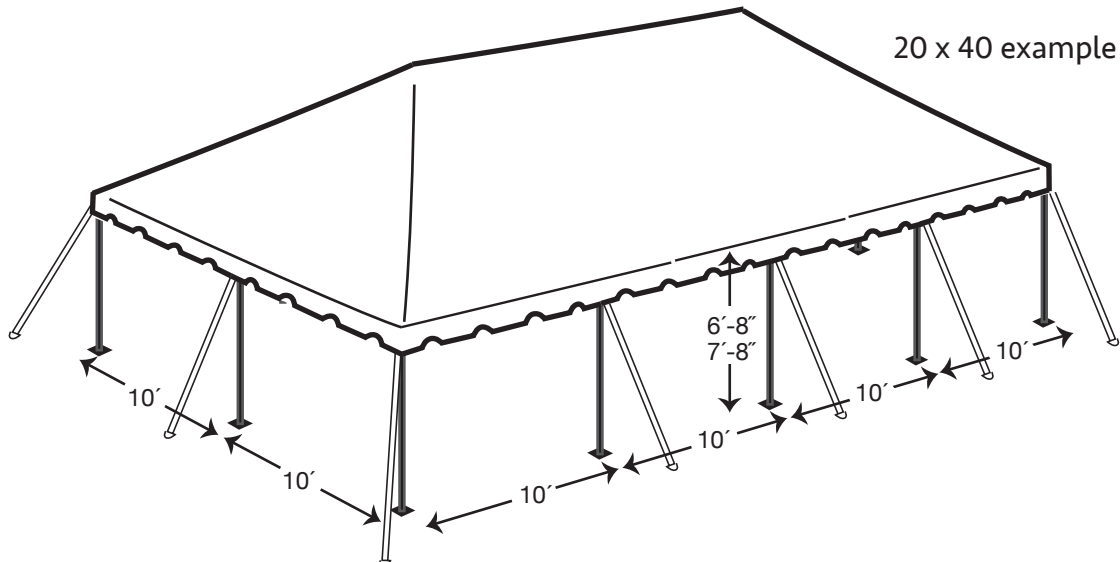

STRIKE PROCEDURE (basically, reverse order from assembly)

- 1.) Undo ratchet strap assemblies/untie ropes
- 2.) Unfasten spring buckle straps, under canopy
- 3.) Remove leg poles, on one long side
(use tent jacks for larger tents)
- 4.) Remove adjacent center, leg poles, on short sides
- 5.) Lower first long side to the ground
- 6.) Repeat, remove leg poles, on remaining long side
- 7.) Lower rest of frame to ground
- 8.) Lay tarp next to a long side of frame
- 9.) Loosen canopy corners
- 10.) Slowly slide canopy off frame—flapping, in unison, as you go
- 10.) Fold and bag canopy (dry canopy)
- 11.) Disassemble poles and connectors
- 12.) Remove ground stakes

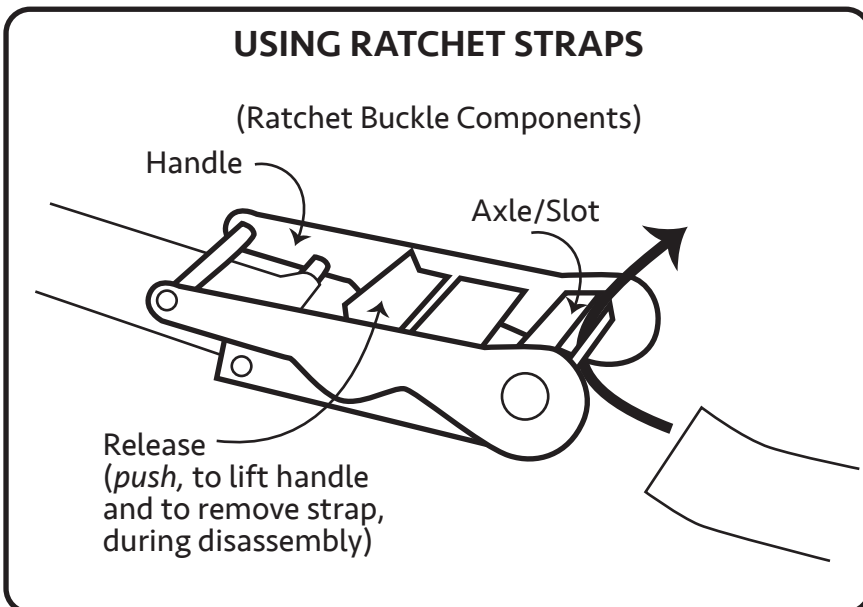
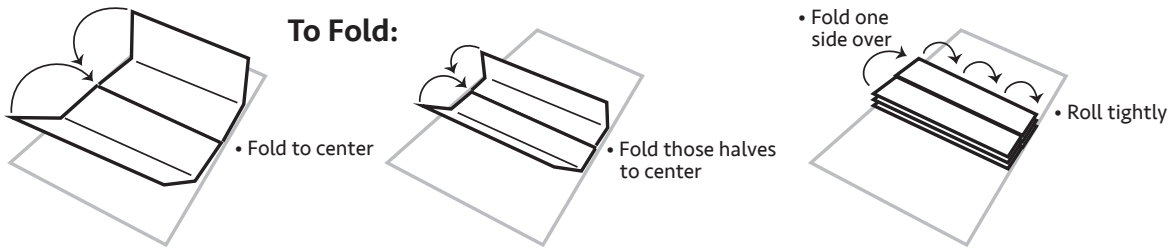

- Release handle, crank until slot is pointing up
- Close handle
- Pass strap underneath and through the slot (as shown)
- While holding the whole strap assembly attach both ends (eg. tent to stake)
- Remove slack, before tightening
- Push 'release'— lift handle and tighten ratchet
- Roll-up any excess strap, put under handle
- Close handle

Appendix A.

- Plans— showing tent sizes, leg pole and connector quantity and locations

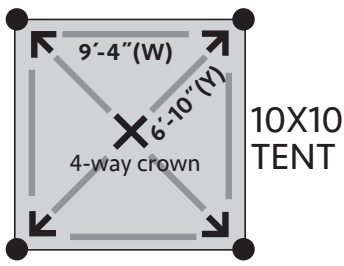

10X10 TENT

(4) spreaders-w
(4) hip rafters-y

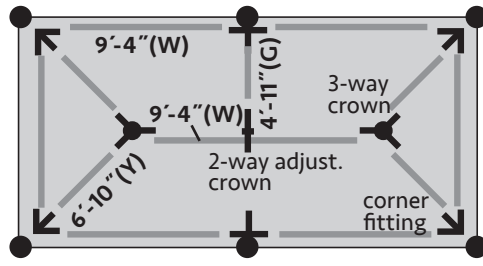

10X20 TENT (7) spreaders-w (4) hip rafters-y (2) rafters-g

Leg pole and base plate positions

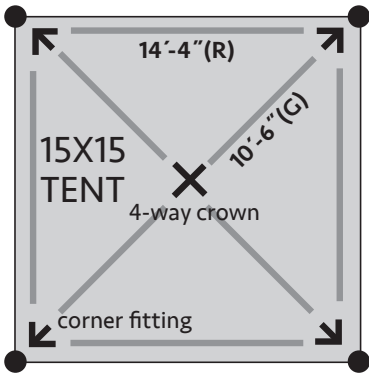

15X15 TENT

(4) spreaders-r (4) hip rafters-g

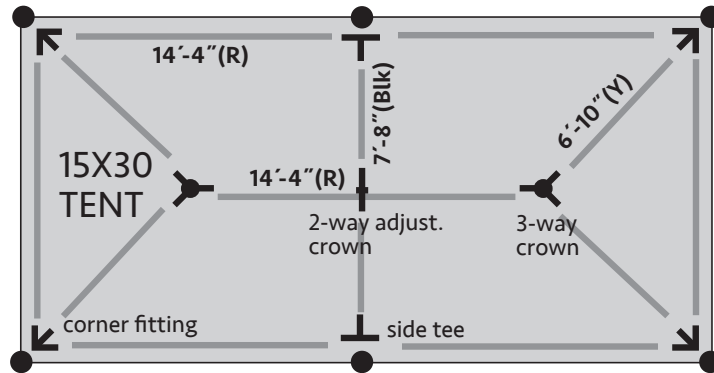

15X30 TENT

(7) spreaders-r (4) hip rafters-y (2) rafters-blk

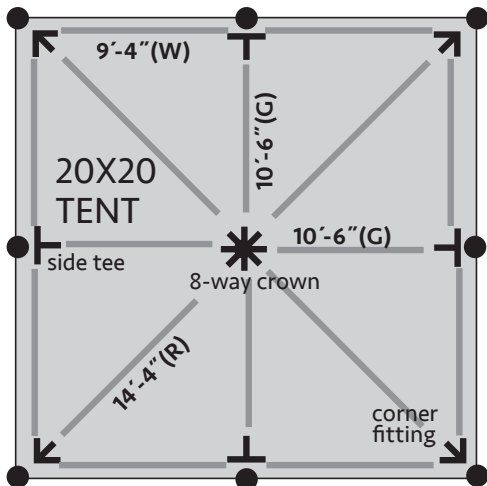

20X20 TENT

(8) spreaders-w (4) hip rafters-r (4) rafters-g

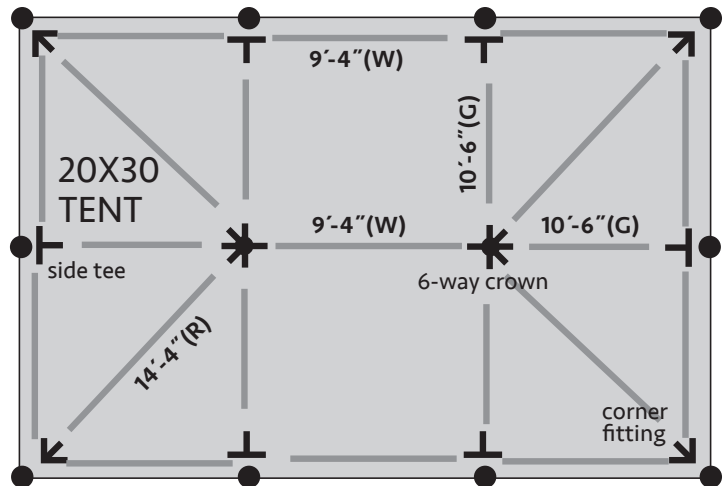

20X30 TENT

(11) spreaders-w (4) hip rafters-r (6) rafters-g

Refer to (page 1) for basic spreader and rafter layout

Appendix B.

- Plans— showing tent sizes, leg pole and connector quantity and locations

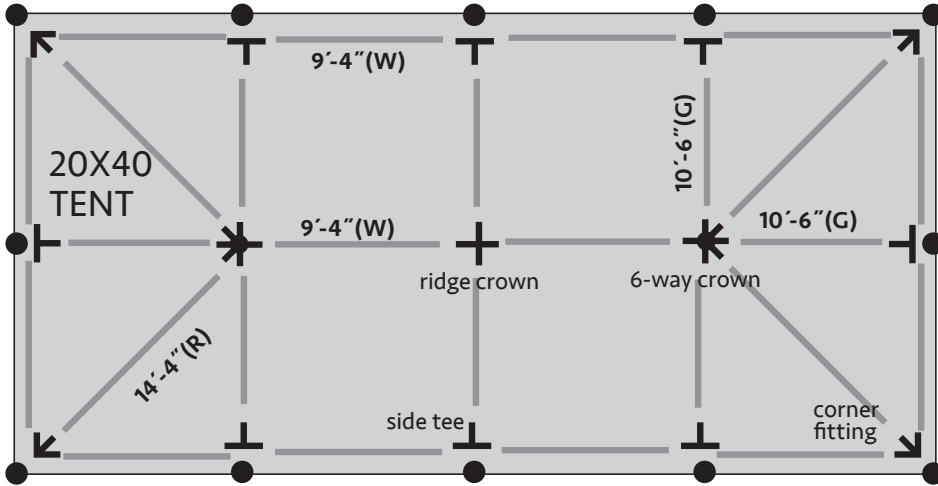

Leg pole and base plate positions

(14) spreaders-w (4) hip rafters-r (8) rafters-g

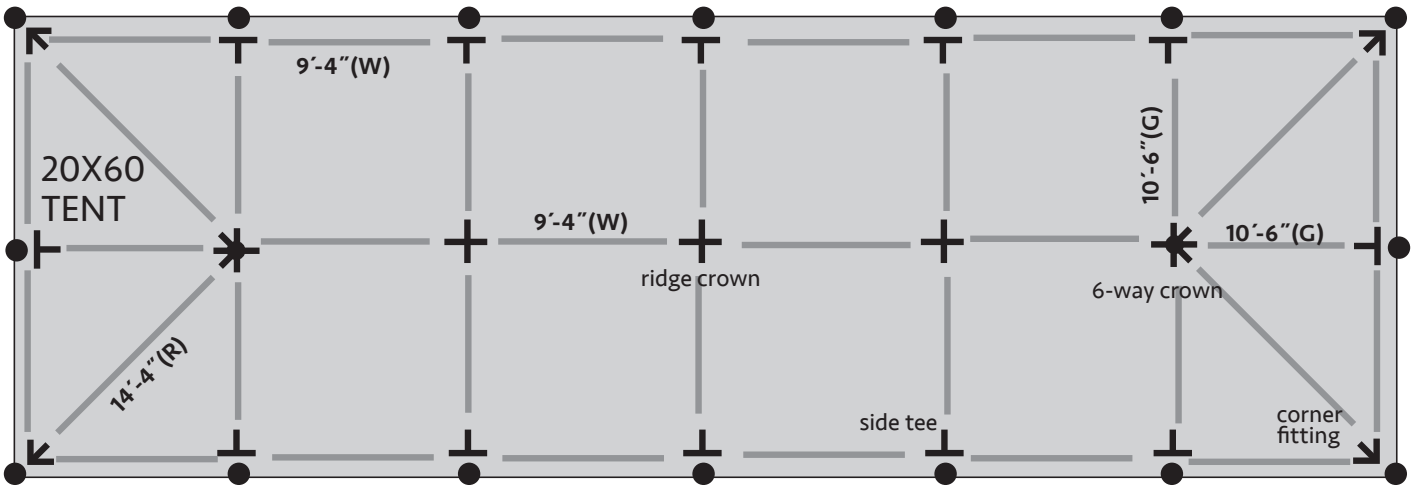

(20) spreaders-w (4) hip rafters-r (12) rafters-g

Refer to (page 1) for basic spreader and rafter layout